

BUY IN PRINT [WORLDWIDE MAGPI.CC/STORE](http://WORLDWIDE.MAGPI.CC/STORE)

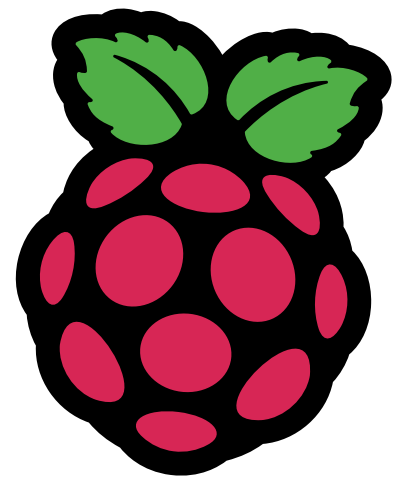

# The *MagPi*



Issue 126 | February 2023 | [magpi.cc](http://magpi.cc)

The official Raspberry Pi magazine

**BRAND  
NEW!**

## RASPBERRY PI

# CAMERA MODULE **3**

SUPER-FAST AUTOFOCUS | 12-MEGAPIXEL & HDR | WIDE-ANGLE OPTION

WALK FASTER  
WITH AN  
**EXOSKELETON**

BUILD AN  
**AIRCRAFT  
TRACKER**

SET UP  
**SMART LIGHTING**

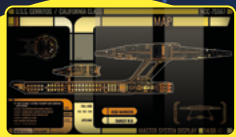

RECREATING A  
**STAR TREK  
COMPUTER**



 **GLOBAL  
DELIVERY**  
[magpi.cc/store](http://magpi.cc/store)



**BUILD A DAC** WITH OFFICIAL AUDIO HATS





# Industrial Raspberry Pi

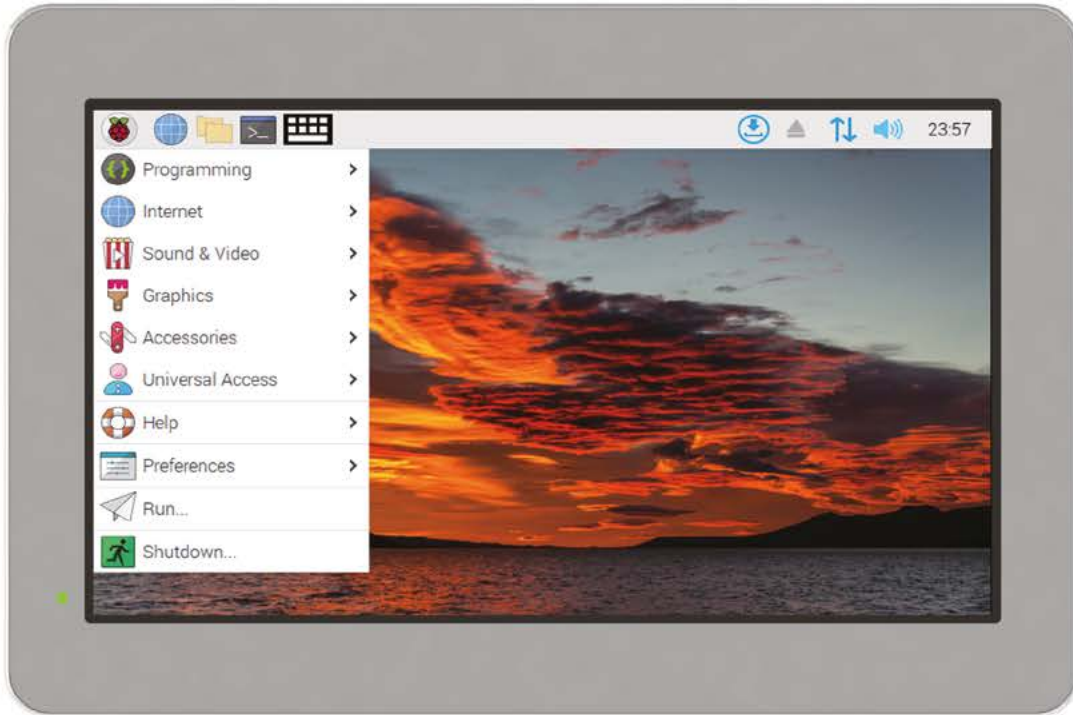

## ComfilePi

The ComfilePi is a touch panel PC designed with high-tolerant components and no moving parts for industrial applications. It features a water-resistant front panel, touchscreen, color LCD (available in various sizes), RS-232, RS-485, Ethernet, USB, I2C, SPI, digital IO, battery-backed RTC (real-time clock), and piezo buzzer.

Use the rear-panel 40-pin GPIO header to expand its features and capabilities with additional I/O boards. The ComfilePi is UL Listed and employs Raspberry Pi Compute Module.

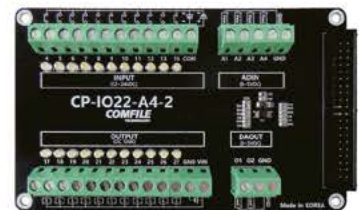

# WELCOME

## to The MagPi 126

It's 2023, and we're off to a great start with a brand-new **Raspberry Pi Camera Module 3 (page 36)**. Camera Module 3 is a great way to add vision and image recognition to your projects, and the latest model is packed with new features to discover.

A new Raspberry Pi product is also a great sign of things to come. Raspberry Pi's Eben Upton has given us a supply chain update (**page 8**), and it's good news. We're already seeing lots of stock in stores and you should find it much easier to pick up projects and start that build this year.

There are also some great new audio boards (**page 10**) that can be turned into pro sound systems, and other audio-themed projects.

Hidden amongst the bevy of new products is an amazing range of features and tutorials this month, from Smart Lights (**page 72**) to a Flight Tracker (**page 54**), and Tide Tracker (**page 66**).

There's a lot to see and do in this issue. Let's get started!

**Lucy Hattersley** Editor



**EDITOR** Lucy Hattersley

Lucy is editor of *The MagPi* and is currently capturing her new Ginkgo tree (nicknamed 'Gina G.' thanks for asking) on a Camera Module 3.

[magpi.cc](http://magpi.cc)

GET A  
**RASPBERRY PI  
PICO W**  
WITH A SUBSCRIPTION!  
**PAGE 34**



# Explore E-ink technology with **EPDK** from **PERVASIVEDISPLAYS** **E-paper display (EPD) Pico Development Kit**

The EPD Pico Development Kit from Pervasive Displays includes everything to start exploring E-ink technology.

- ⇒ EPD Extension board Gen 3 (EXT3-1) board
- ⇒ Raspberry Pi Pico RP2040 (with pin header)
- ⇒ 2.66" E-ink Monochrome Display with Fast Update
- ⇒ 20-pins and 2-pins bridging cable
- ⇒ Pin mapping label (3 pieces)

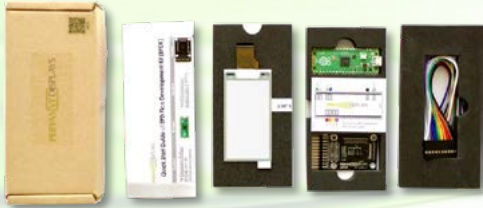

Grab a USB cable, download the library and start exploring E-ink technology today!

Learn more **PERVASIVEDISPLAYS**  
[www.pervasivedisplays.com](http://www.pervasivedisplays.com)



Buy it **sparkfun**  
ELECTRONICS  
[www.sparkfun.com/products/19219](http://www.sparkfun.com/products/19219)



## *Entaniya* **Cube Case 01** for Single Board Computers

Cube Case 01 provides safe housing for main units of Single Board Computers, e.g. Raspberry Pi 3 or 4. It has a high-quality machined aluminum frame, with many options such as interchangeable acrylic panels and perforated panels that allow cables to pass through.

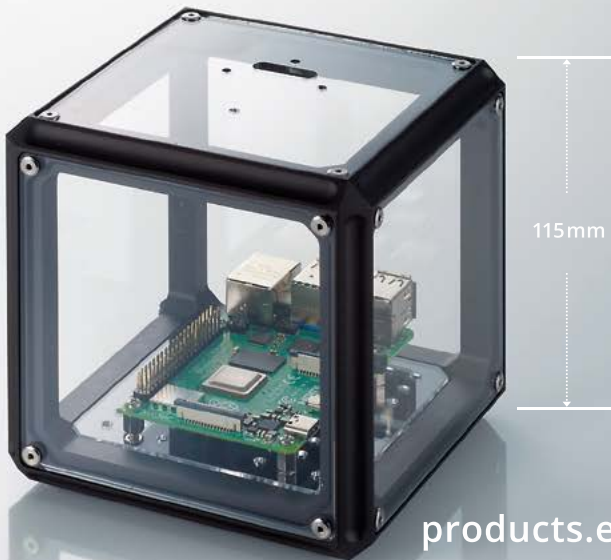

[products.entaniya.co.jp/en/](http://products.entaniya.co.jp/en/)

Dustproof and drip-proof in use with the included sealing mats



A free configurable case with replaceable panels



Compatible with Entaniya All-Weather Case WC-01 for Raspberry Pi Camera Module 2 (sold separately)



For inquiries, please contact [products@entaniya.co.jp](mailto:products@entaniya.co.jp)

Entaniya Co.,Ltd., Nishiwaseda 2-5-13, Shinjuku-Ku, Tokyo 169-0051, Japan | [www.entaniya.co.jp](http://www.entaniya.co.jp)

# Contents

► Issue 126 ► February 2023

## Cover Feature

### 36 Raspberry Pi Camera Module 3

## Regulars

- 08 News: supply chain update
- 10 News: Raspberry Pi audio boards
- 12 News: KiCad fundraiser
- 92 Your Letters
- 97 Next Month
- 98 The Final Word

## Project Showcases

- 14 PiRitos
- 18 Exoskeleton
- 22 Team Pinball
- 26 Photon
- 28 Odyssey Lights
- 32 PaperPi V3

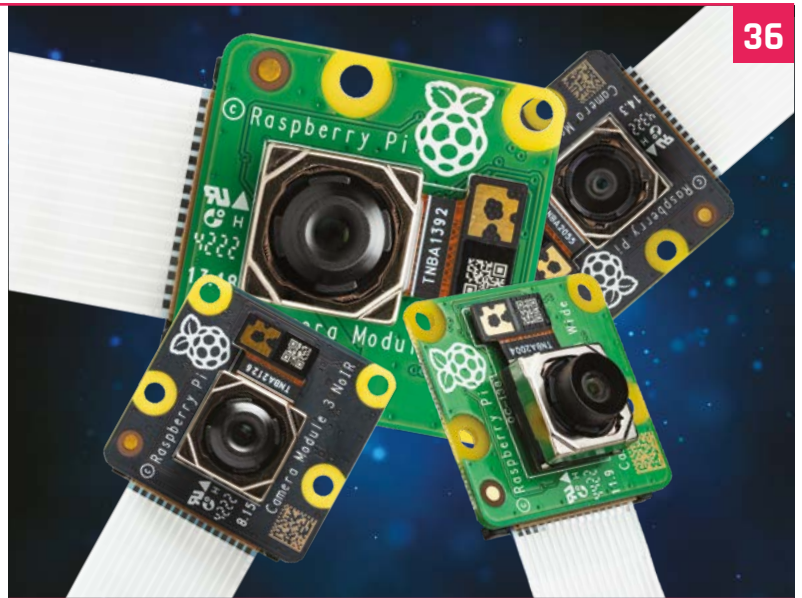

36



26

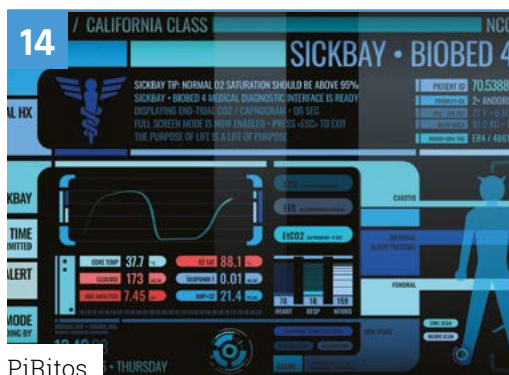

PiRitos

Photon

The MagPi magazine is published monthly by Raspberry Pi Ltd. Publishers Service Associates, 2406 Reach Road, Williamsport, PA, 17701, is the mailing agent for copies distributed in the US. Application to mail at Periodicals prices is pending at Williamsport, PA. POSTMASTER: Send address changes to The MagPi magazine c/o Publishers Service Associates, 2406 Reach Road, Williamsport, PA, 17701.

**Tutorials**

- 46 Animate in Scratch
- 50 Create a toy Chatter Box
- 54 Build a flight tracker
- 60 Design a PCB
- 66 Track the tides



50 Create a toy Chatter Box



66 Track the tides

**The Big Feature**



72

Smart lights

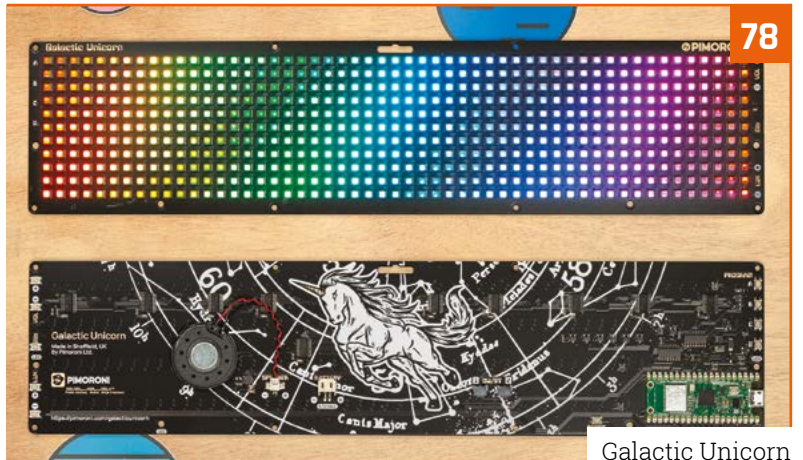

78

Galactic Unicorn

**Reviews**

- 78 Galactic Unicorn
- 80 10 amazing artistic programs
- 82 Learn LibreOffice

**Community**

- 86 Alex Martinez interview
- 88 This Month in Raspberry Pi

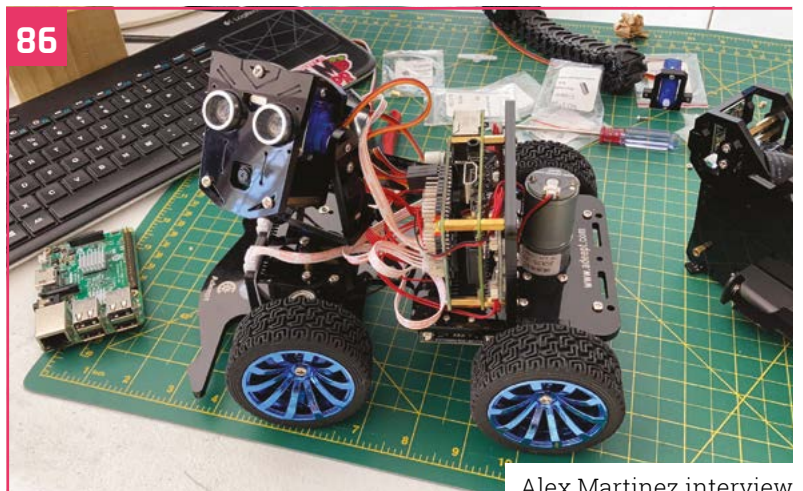

86

Alex Martinez interview

**WIN** 1 OF 10 **RASPBERRY PI CAMERA MODULE 3** **95**



**DISCLAIMER:** Some of the tools and techniques shown in The MagPi magazine are dangerous unless used with skill, experience, and appropriate personal protection equipment. While we attempt to guide the reader, ultimately you are responsible for your own safety and understanding the limits of yourself and your equipment. Children should be supervised. Raspberry Pi Ltd does not accept responsibility for any injuries, damage to equipment, or costs incurred from projects, tutorials or suggestions in The MagPi magazine. Laws and regulations covering many of the topics in The MagPi magazine are different between countries, and are always subject to change. You are responsible for understanding the requirements in your jurisdiction and ensuring that you comply with them. Some manufacturers place limits on the use of their hardware which some projects or suggestions in The MagPi magazine may go beyond. It is your responsibility to understand the manufacturer's limits.

# SELECTION STARTS HERE



With over 2,300 name-brand, industry-leading suppliers—be confident we've got your electronic component and automation needs covered.

Find it at [digikey.co.uk](https://www.digikey.co.uk) today, or call 0800 587 0991.



Digi-Key is a franchised distributor for all supplier partners. New products added daily. Digi-Key and Digi-Key Electronics are registered trademarks of Digi-Key Electronics in the U.S. and other countries. © 2023 Digi-Key Electronics, 701 Brooks Ave. South, Thief River Falls, MN 56701, USA

ECIA MEMBER  
Supporting The Authorized Channel

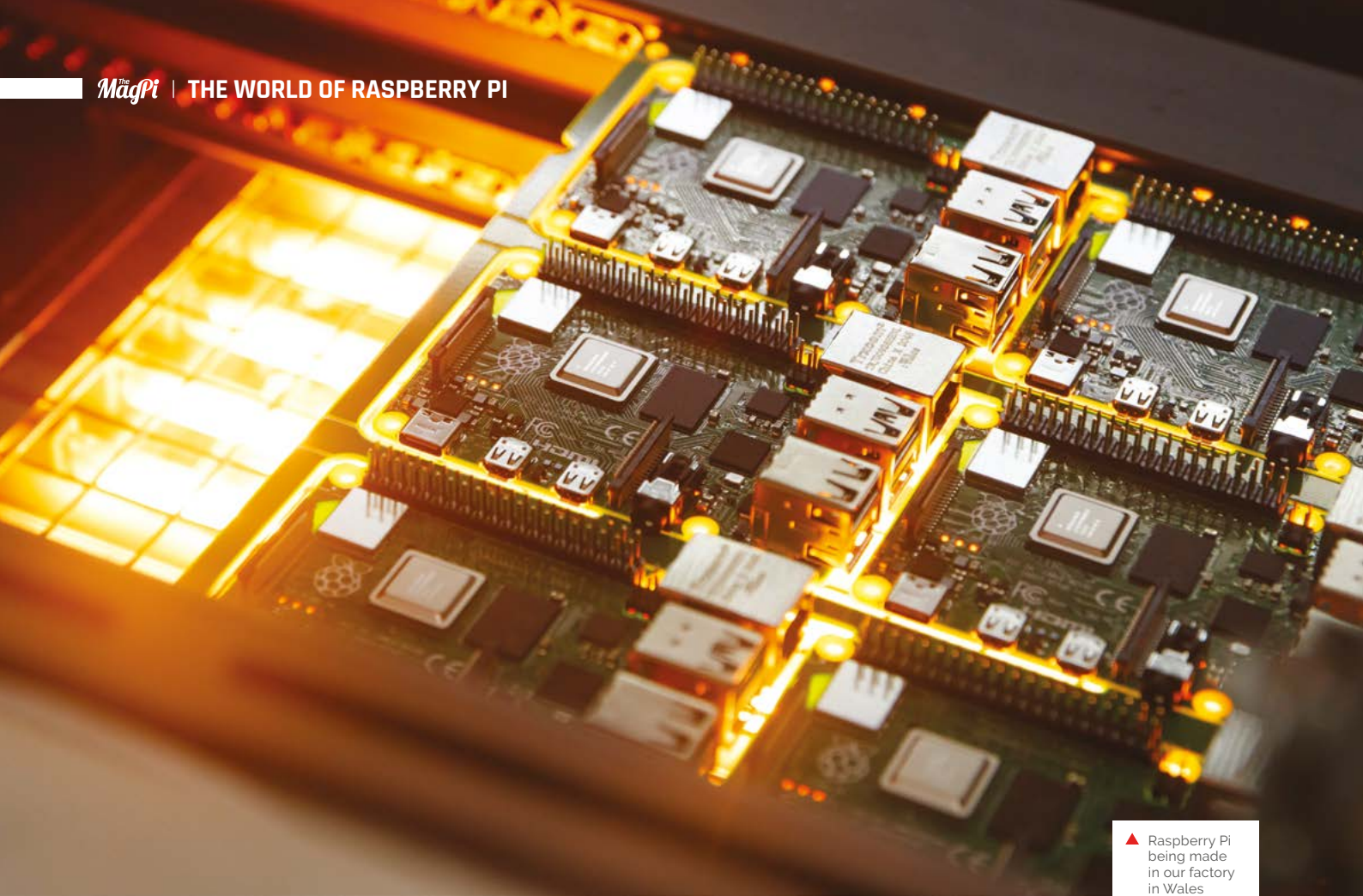

▲ Raspberry Pi being made in our factory in Wales

# Supply chain update – it's good news!

For the first time in a couple of years of semiconductor supply chain hell, we've got some good news for you. By **Eben Upton, Raspberry Pi Founder and CEO**

**If you've tried to buy pretty much anything recently, you'll realise that we are in the midst of a global supply chain crisis, affecting everything from cement and fence-posts to jewellery and clothing.** Various aspects of this crisis have impacted our business, but persistent shortages of the semiconductor devices we use to build Raspberry Pi single-board computers and modules has been particularly challenging for us (and a lot of other tech businesses) to manage.

## Happy New Year

As a thank-you to our army of very patient enthusiast customers, we've been able to set aside a little over a hundred thousand units, split across

Zero W, 3A+ and the 2GB and 4GB variants of Raspberry Pi 4, for single-unit sales. These are flowing into the Approved Reseller channel now, and this is already translating into better availability figures on [rpilocator.com](https://rpilocator.com). While we're not quite out of the woods yet, things are certainly improving. For those of you looking to buy a Raspberry Pi for hobby projects or prototyping, the advice we gave back in April still holds: always buy from an Approved Reseller (they're under contract with us to sell at no more than the RRP); use tools like [rpilocator](https://rpilocator.com) to keep an eye on which resellers have recently received stock; and consider whether your project is a good fit for Raspberry Pi Pico or Pico W, which remain in a strong stock position.



And if you're an industrial or enterprise customer who is experiencing supply issues, and you have not already spoken to us, please get in touch with our commercial team at [business@raspberrypi.com](mailto:business@raspberrypi.com).

We will continue to actively manage our commercial and industrial customers through 2023, ensuring that they receive the units they need, and we've made some changes to make sure that inventory-building behaviour, which would otherwise prolong the shortage for everybody else, can't take place.

### Increasing single-unit sales

Although we are sitting on substantial order backlogs from commercial customers, we expect to gradually increase the fraction of our output which we dedicate to single-unit sales during 2023 until we're back in our pre-pandemic situation. The chip allocations we've received for next year mean that by the end of the third quarter, the channel will have recovered to its equilibrium stocking level, with hundreds of thousands of units available at any given time. At that point, we will have spent a little over two years in a low-stock position: a measure of the severity and persistence of the shortages.

As we go through the year, it is likely that you'll see Zero and Zero W come back into general availability first, followed by products like

“ You'll be able to buy as many as you want at a time ”

Raspberry Pi 3A+ which do not have an extensive industrial customer base; and, finally, the various versions of Raspberry Pi 4.

### Raspberry Pi Zero cost increase

An unpleasant side effect of the supply chain crisis has been an increase in the cost of pretty much every component that goes into a Raspberry Pi, from PCBs to connectors to silicon. We've generally absorbed these cost increases ourselves, holding the prices of our products constant, and making less profit on each unit. The exceptions have been the 2GB variant of Raspberry Pi 4, which we returned to its original \$45 price point; and Compute Module 4, where we applied an across-the-board \$5 price increase to all variants.



Our original Raspberry Pi Zero products have always had very low margins, and after the recent cost increases they are no longer commercially viable at their original price points – if we kept to the old price, we'd be making a loss on every single Zero we sell. We have therefore reluctantly decided to increase the price of Zero from \$5 to \$10, and Zero W from \$10 to \$15. There is an upside here, though: once Zero products return to volume availability, we no longer expect to see the single-unit limitations that have been a feature of Zero since its launch in 2015 — you'll be able to buy as many as you want at a time. 📦

▲ Over 100,000 units are being delivered into the customer supply chain

▼ The Raspberry Pi Zero is returning to volume availability

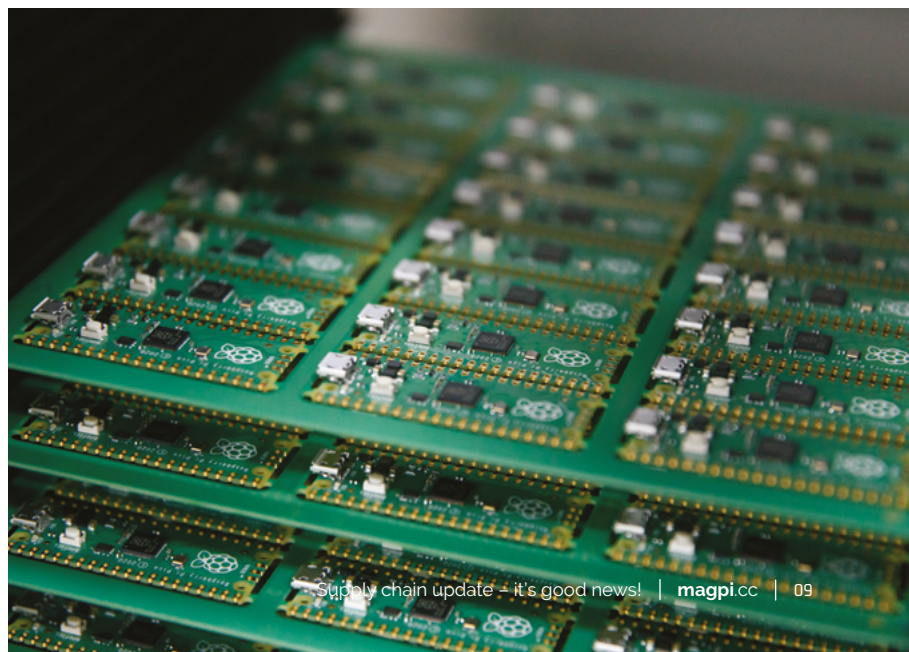

# Raspberry Pi audio boards for your hi-fi projects

New Raspberry Pi Audio boards based on IQAudio with a refreshed circuit design. By **Eben Upton, Raspberry Pi Founder and CEO**

**B**ack in 2020, we welcomed the IQaudio family of hi-fi audio products into the Raspberry Pi family. This was the first and so far the only time we've acquired electronic products from someone else, rather than developing them ourselves. That we made an exception for IQaudio is a testament to what Gordon, Sharon, and Andrew had built together.

The line-up offers you a lot of choice, depending on your preferences and use case. The \$20 DAC+, our lowest-cost audio HAT, and \$25 DAC Pro, our highest-fidelity HAT, are both designed for use with an external amp. Then there's the \$30 DigiAMP+ with an integrated amplifier on board, which together with a

Raspberry Pi offers a complete hi-fi in an exceptionally compact package. Lastly there's Codec Zero, a low-cost audio I/O board at \$20: sporting LEDs and a tactile button, it supports a range of audio input and output devices, making it a terrific starting point for all kinds of homebrew projects. If you're not sure which board you need, we've got a handy comparison guide for you at [magpi.cc/audiooverview](https://magpi.cc/audiooverview).

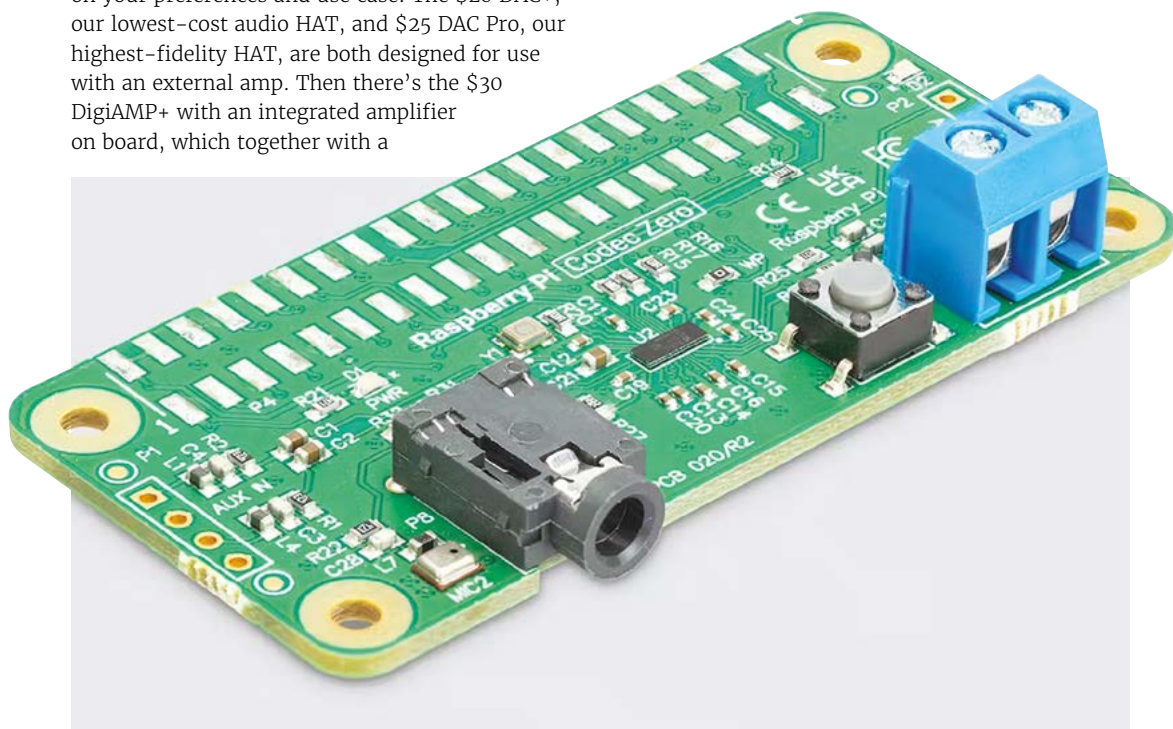

▶ The Raspberry Pi Codec Zero is a low-cost audio I/O board at \$20

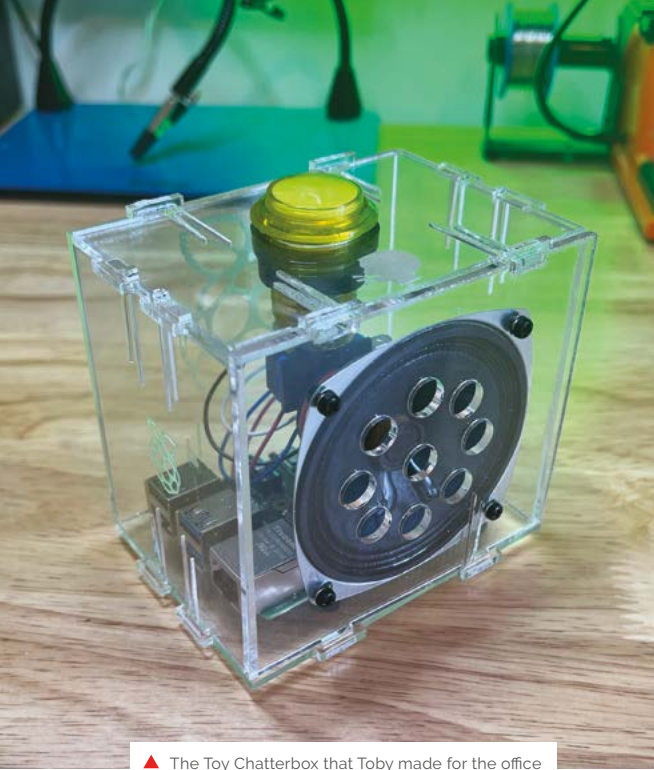

▲ The Toy Chatterbox that Toby made for the office

### New and improved

We're marking the second anniversary of the acquisition by making all four former IQaudio products a bit more Raspberry Pi-like. Buy a DAC+, DAC Pro, DigiAMP+, or Codec Zero from one of our

“ The great hi-fi-quality sound you expect from IQaudio, and the low prices you expect from Raspberry Pi ”

Approved Resellers today, and you'll likely end up with a green Raspberry Pi-branded board, replacing the original black colour scheme. And the eagle-eyed among you will notice a few minor layout and connector changes, aimed at making the boards simpler and quicker to manufacture.

This sort of continuous design-for-manufacturability work is the hallmark of all Raspberry Pi products.

Despite the changes, you'll get the great hi-fi-quality sound you expect from IQaudio, and the low prices you expect from Raspberry Pi. And, of course, the boards are still made here in the UK, with Bedford-based Asteelflash taking over from Ashgill Electronics.

Not sure where to start? We've got you covered. Toby, our Maker in Residence, has made a toy chatterbox tutorial which you can follow along with (page 50): it'll take you all the way from a standing start to making a box that burps. Of course, if burping's not your thing, you can make your box emit whatever noises you like. **M**

▼ DigiAMP+ features an integrated amplifier to offer a complete hi-fi in an compact and low-cost package

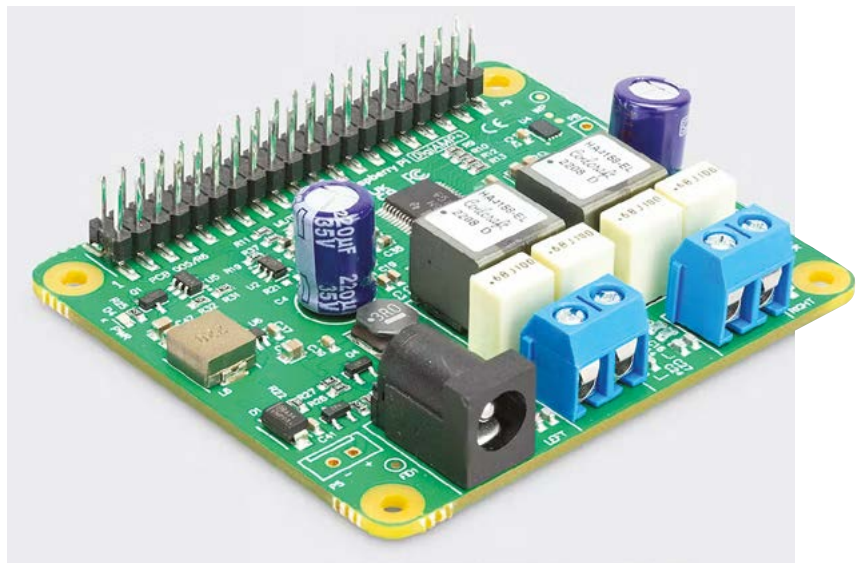

## Raspberry Pi Audio Boards

Item	Line out	Balanced out	Stereo speakers	Mono speaker	Headphones	Aux in	Aux out	Ext mic	Built-in mic	More info
DAC Pro	✓	✓			✓					<a href="http://magpi.cc/dacpro">magpi.cc/dacpro</a>
DAC+	✓				✓					<a href="http://magpi.cc/dac+">magpi.cc/dac+</a>
DigiAMP+			✓							<a href="http://magpi.cc/digiamp+">magpi.cc/digiamp+</a>
Codec Zero				✓		✓	✓	✓	✓	<a href="http://magpi.cc/codeczero">magpi.cc/codeczero</a>

# Supporting KiCad open-source design automation software

Raspberry Pi Ltd is helping KiCad with its end-of-year funding drive by matching donations made on KiCad's website up to \$5000. By **James Adams, Raspberry Pi COO**

**K**iCad is a free, open-source suite of CAD tools for schematic capture and printed circuit board (PCB) design. It allows you to draw your electronic circuits in schematic form, using graphically represented components and wires, and then transfer this data into a PCB editor which is used to place the components and draw the copper tracks and vias (electronic connections) that join them.

The tools know what is connected to what, and also what design rules must be followed (such as what is the smallest width of copper track you can use), and they help the designer make sure that the design is

manufacturable. Once a design is completed, the tool will spit out data that a PCB manufacturer can use to make a physical PCB.

I have long been a fan of KiCad, having started using it in 2011 for a hobby project. It had a few rough edges back then, but was very usable even for fairly complex designs. When I joined Raspberry Pi at the start of 2013, I was already thinking that it would be nice to use it for commercial projects.

## Supporting development

In 2014, we sponsored the work to add differential pair routing support to KiCad, which was something it had been lacking. Differential pairs are traces on the PCB that have a controlled geometry, and therefore impedance, and are used for high-speed signals such as HDMI and USB.

The addition of differential pair support, as well as the many other improvements to the tool since then, have meant we are now able to use it for some of our product designs. Dominic Plunkett developed the Compute Module 4 IO board using KiCad, and the design database is free for anyone to download and use as a starting point for their own CM4 projects; you can download a zip file of the database: [magpi.cc/designdatabase](https://magpi.cc/designdatabase). We have also used KiCad to develop the RP2040 minimal

▼ KiCad running on a Raspberry Pi 4

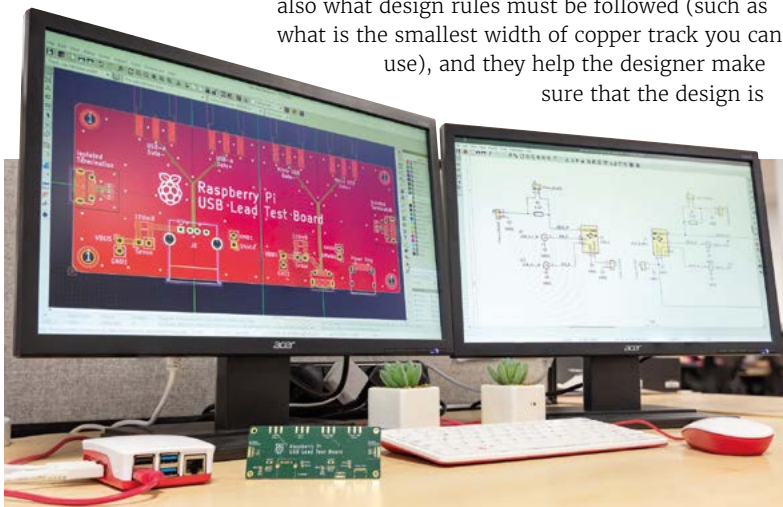



design, as well as the Pico VGA demo board as open designs: you can find both in the Hardware Design with RP2040 guide ([magpi.cc/hwdesignrp2040](https://magpi.cc/hwdesignrp2040)). While it's likely we'll always need to use high-end, non-free CAD tools for certain products, especially those that require very high-speed design and simulation, we are extremely impressed with how far KiCad has come. It's amazing to have an open-source tool that's this powerful and freely available.

## KiCad on Raspberry Pi 4

While KiCad has been available on Raspberry Pi OS for some time, the default version in Debian Bullseye (which is what Raspberry Pi OS is built on) was fairly old.

Recently we have made a newer version of KiCad available. Typing `sudo apt install kicad` on an up-to-date Raspberry Pi OS Bullseye image will install it. Changes made in the newer version 6 KiCad codebase have brought improved OpenGL hardware acceleration, and therefore much better performance on Raspberry Pi computers.

One of our engineers, Richard Jones, recently completed a PCB for an internal test platform and designed it entirely using KiCad running on a Raspberry Pi 4. He has found that the new version works well and is very usable.

“ It's great to see KiCad maturing into such a capable platform ”

## Designing a USB test board

Richard has also used it for other projects. When you've got a big pile of USB leads, it can be frustrating unless you've labelled them really carefully; inevitably the lead you'll reach for will be broken, or it won't support data transfer. This can mean hours of fruitless debugging, when all you needed was a lead that wasn't broken. This is where Richard's design for a test board for USB leads comes in, and you can take a look at it – in KiCad on your Raspberry Pi – if you like, because we've made the design available for download under an open licence, with no limitations on reuse ([magpi.cc/usbtesterkicad](https://magpi.cc/usbtesterkicad)).

It's great to see KiCad maturing into such a capable platform, and we are looking forward to seeing what new features will be made available in the upcoming versions. Meanwhile, please support them by heading over to the KiCad website to donate ([kicad.org](https://kicad.org)). We will be pleased to match the first \$5,000 of donations. 

▲ Designing a USB test board inside KiCad

# PiRitos

The computer interfaces of the future were designed in the 1980s, and lovingly recreated in the 2020s.

**Rob Zwetsloot** boldly checks it out



**James Mitchell**

Raspberry Jam Berlin organiser and Software QA Engineer, James is also a keen Raspberry Pi hobbyist and user.

[raspberrypi.com](http://raspberrypi.com)

**S**tar Trek: Lower Decks is a surprisingly faithful *The Next Generation*-era *Star Trek* show with a few extra jokes thrown in – and because it’s set in that era, the familiar LCARS computer interface designed by Michael Okuda for *Next Gen* is seen throughout the show. This interface has been replicated a lot over the years, but this version is a little different.

“Ritos is a website LCARS system based off of *Star Trek: Lower Decks*,” James Mitchell, creator of PiRitos, tells us. “It was created by meWho Rob (@meWho\_System47). Basically, it is a pretty screensaver-type site for fans. PiRitos is the extension of the Ritos system, hosted on a Raspberry Pi and has some extra server-based features. For example, connecting to sensors and syncing red alert status to other connected web clients.”

This means if you really want to do some light *Star Trek* roleplay, you can have several screens in one room which have some degree of connectivity – such as displaying a red alert.

“After that, I connected LEDs to the back of my monitor and they would pulse red if the status was ‘red alert’,” James continues. “I connected a Raspberry Pi Sense HAT to the Flask server, so room weather data would be sent to the PiRitos system. Finally, for a bit of fun, I connected a Pico to the server and it transmitted its own internal temp sensor reading to the Flask server. This was also sent to all the connected clients.”

## Isolinear processing

The project itself started solely as Ritos in the browser but, after seeing it in action, James asked meWho Rob if he could have the source code to make PiRitos. He used it as an excuse to learn Flask ([magpi.cc/flask](http://magpi.cc/flask)) and Socket.IO, as he reckons he learns best via a project.



The Ritos website runs on a server and is displayed on multiple screens. Activating Red Alert on one will display it on the others

“meWho Rob decided to help me for a few weeks, and we managed to work together to open some of the JS functions and attached the Socket.IO code,” James explains. “After that, it was a simple case of having Flask and Socket.IO communicate to the connected clients. Once communication between server and client was working, it was super-easy to extend to physical hardware like LEDs and sensors.”

## Second contact

The result is fantastic – we mentioned it in our previous issue after it got shared far and wide on social media, with many Raspberry Pi and *Star Trek* fans getting excited by the project.

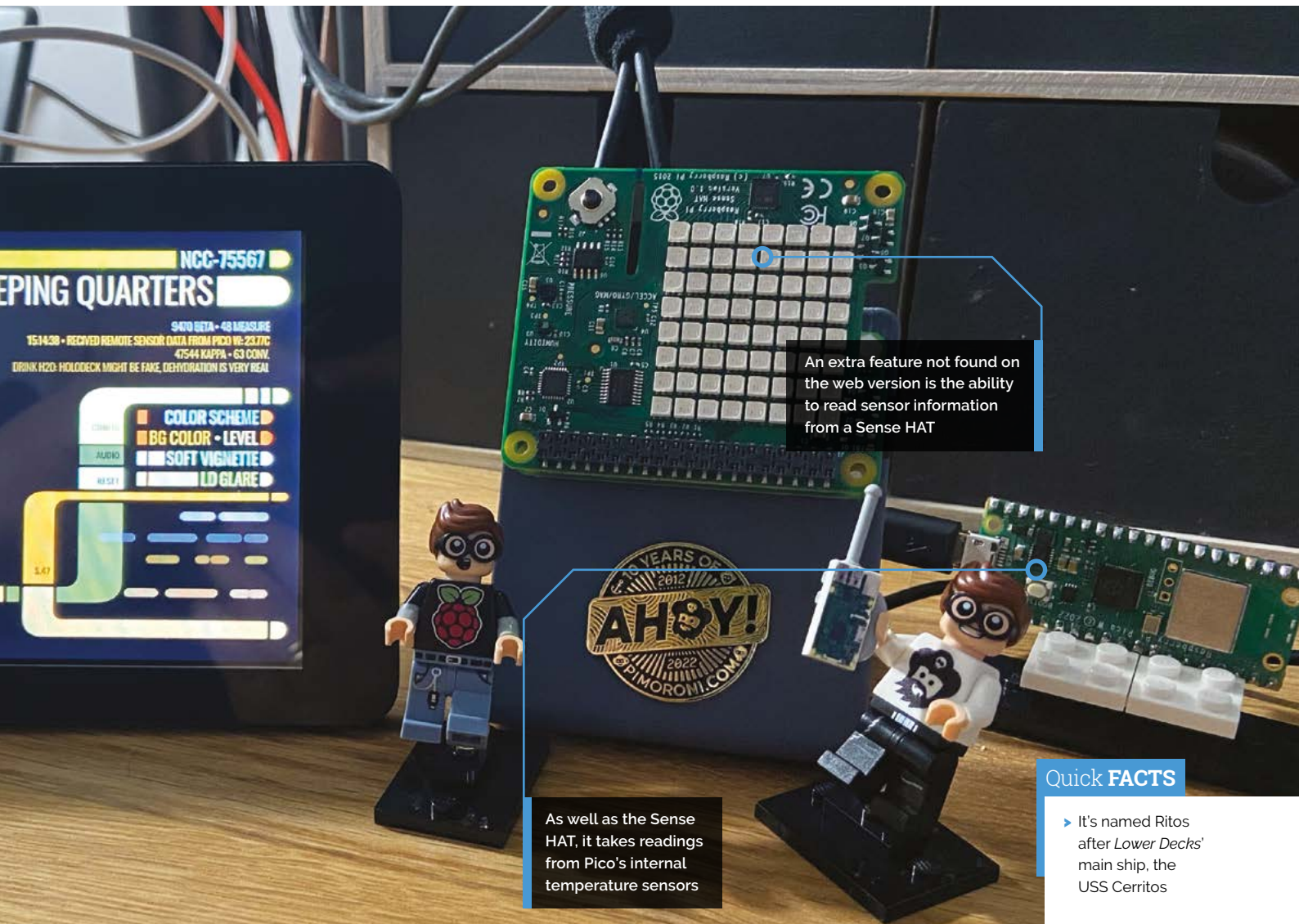

An extra feature not found on the web version is the ability to read sensor information from a Sense HAT

As well as the Sense HAT, it takes readings from Pico's internal temperature sensors

**Quick FACTS**

- ▶ It's named Ritos after *Lower Decks'* main ship, the USS Cerritos
- ▶ It took James about two weeks to make
- ▶ There are plenty of sci-fi references hidden in the interface...
- ▶ ...like *Dr Who*, *Stargate*, and more!
- ▶ There's also a *Dr Who* clock version here: [mewho.com](http://mewho.com)

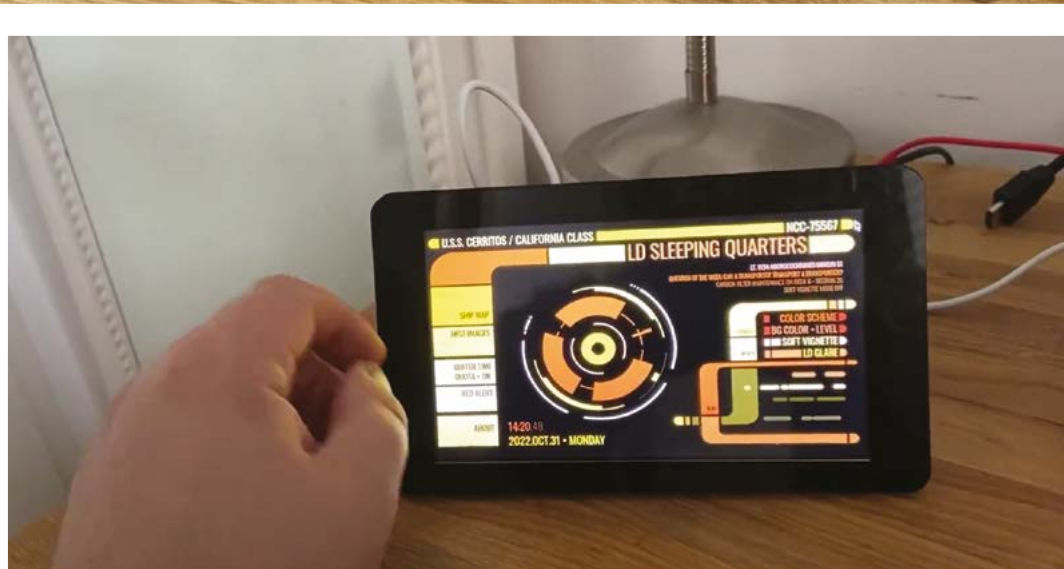

◀ PiRitos can run just fine on a Raspberry Pi with a touchscreen



▲ With PiRitos you can have several systems hooked to one instance, allowing them to work together



▲ The ship map has many functions... and looks very cool

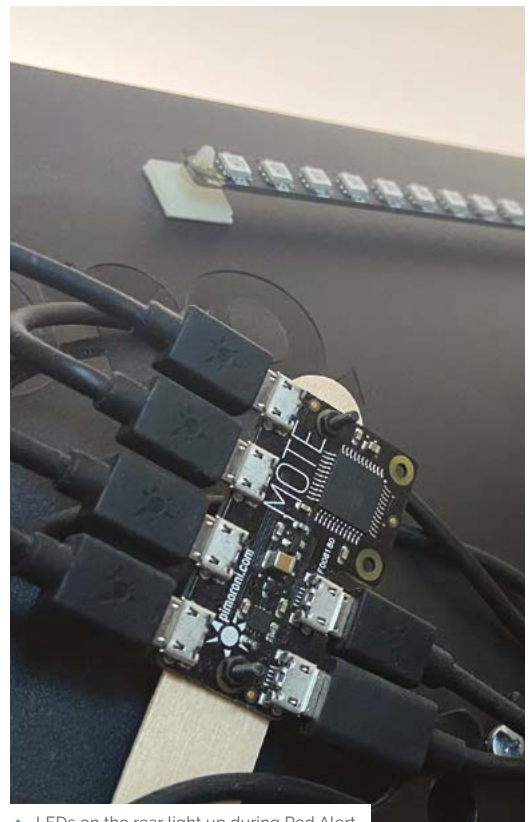

▲ LEDs on the rear light up during Red Alert





“At the moment, I don’t think I have any plans to do anything more with the PiRitos system,” James admits. “It’s been a bit of fun and a great learning experience, but it would take a lot of work

▲ You won’t miss a Red Alert this way!

“ He used it as an excuse to learn Flask and Socket.IO, as he reckons he learns best via a project ”

to get this into something more useful. Personally, I want to tinker more with connecting Raspberry Pi with other smart services like turning on/off smart plugs and lights. This could go into PiRitos at some point. Or the reverse, getting a voice assistant, like Alexa, to set the red alert status would be awesome, but [we] don’t have any road map for that... I know [meWho Rob is] moving on to make a LCARS site based off the *Picard* series, and maybe we can work on getting that to also work with Raspberry Pi!” [M](#)

## Navigate PiRitos



**01** On the home screen, you can adjust your display settings and access different parts of the ship’s computer, such as JWST images to analyse.



**02** The map shows a full layout of the USS Cerritos, where you can zoom in on different sections and even find hidden Easter eggs, such as Cetacean Ops, and interesting holodeck programs.



**03** The sickbay screen shows randomised *Star Trek* species, and the conditions that brought them there in the first place.

# Exoskeleton

This groundbreaking device aids walking while understanding that people move in different ways, as **David Crookes** explains



## Stanford Biomechatronics Laboratory

Stanford Biomechatronics Laboratory develops wearable robots to improve efficiency, speed, and balance while walking and running.

[magpi.cc/biomechstan](http://magpi.cc/biomechstan)

**R**aspberry Pi always has the potential to put a spring in our step but, in the case of this project, it's doing so in a literal sense. A research group at Stanford University has designed a robotic exoskeleton – an external frame that aims to support the body – with the aim of helping people with mobility impairments to walk and run more quickly. It's worn over the lower leg like a boot, and it has the potential to be revolutionary.

According to the team, exoskeletons of this nature, while proving effective in reducing the energy required to walk, tend to be expensive. They are also usually tethered which, as you can imagine, would be restrictive. The Stanford Biomechatronics Laboratory's exoskeleton, however, is neither of those things. And much of that is down to the incorporation of a Raspberry Pi 4 computer linked up to a host of sensors, a motor, and a motor driver.

"We selected Raspberry Pi specifically because it is low-cost, and quite capable for integrating many sensors and running multiple threads of code at the same time," Patrick Slade tells *The MagPi*. "The Raspberry Pi is also really nice because we can write code in Python, which is much easier to work with when validating a complex device than typical microcontrollers that might run Arduino or C."

### Gathering momentum

Patrick worked on the exoskeleton as a PhD student and he's now a postdoctoral scholar at Stanford. The project is led by associate

professor of mechanical engineering Steve Collins and the work has, so far, performed well in extensive testing. The key to this exoskeleton is that it's personalised to suit different ways that humans walk. "It resulted in exceptional improvements in walking speed and energy economy," Steve says.

For many years, the team has been using exoskeleton emulators to train a machine-learning-based model. It has involved volunteers

“ We selected Raspberry Pi specifically because it is low-cost, and quite capable for integrating many sensors ”

being hooked up to expensive devices so that motion and energy expenditure data can be collected and this has enabled the boot to work out the best way of assisting an individual.

With the untethered exoskeleton, a wearer simply needs to walk around for about an hour in order for the system to figure out a pattern, then adjust and create a suitable aid. To do this, Raspberry Pi 4 reads sensor data and performs real-time control and optimisation at 200Hz, the

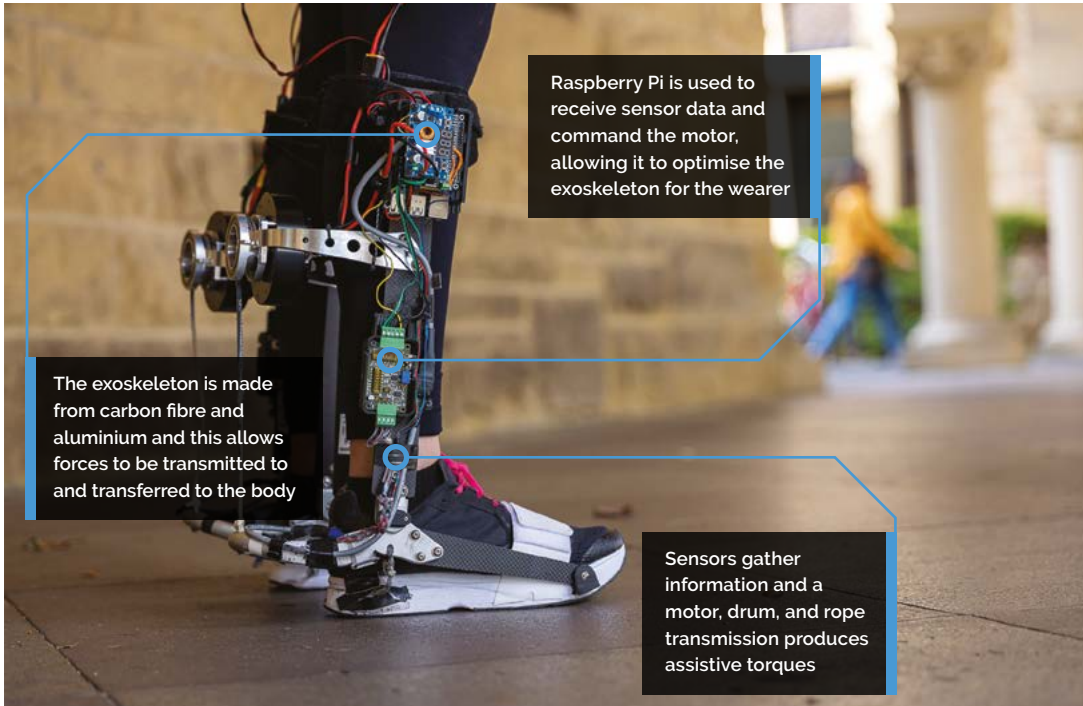

Raspberry Pi is used to receive sensor data and command the motor, allowing it to optimise the exoskeleton for the wearer

The exoskeleton is made from carbon fibre and aluminium and this allows forces to be transmitted to and transferred to the body

Sensors gather information and a motor, drum, and rope transmission produces assistive torques



**Quick FACTS**

- ▶ It's a successful real-world exoskeleton
- ▶ The device will help people to walk
- ▶ Raspberry Pi is a key component...
- ▶ ...and it's helping to lower the costs
- ▶ Initial research suggests it's already successful

◀ The exoskeleton has been extensively tested outside to see how much quicker people are able to walk when wearing it



- ▶ One important aspect of the exoskeleton is that it is untethered and self-contained
- ▶ It's a bulky device and the electronics are on view, but this is still very much a work in progress





team says, and the benefits can be felt within the first 15 minutes.

### Moving forward

So far, the results are heading in the right direction. People are not only walking nine percent faster, they are expending 17 percent less energy too. The researchers say the difference is equivalent to “taking off a 30-pound backpack.” What’s more, it’s a greater improvement to walking than any other exoskeleton made before.

“ It resulted in exceptional improvements in walking speed and energy economy ”

As you can imagine, this is sure to have major benefits for older people and those who are experiencing mobility decline. “It will allow people to lead more active, independent, and meaningful lives,” says Patrick. Of course, much more work is needed and, to bring it to market, the research group will be seeking commercial partners, but the exoskeleton could soon be working alongside traditional aids such as wheelchairs and walkers at some point in the near future. [M](#)

◀ You can read more about the project in a scientific article published in Nature, at [magpi.cc/exoarticle](http://magpi.cc/exoarticle)

## Perfecting a walk



**01** First of all, wearers don the exoskeleton and place the battery pack on their waist. The battery weighs 0.3kg and powers the device for 30 minutes.



**02** When the wearer begins to walk, sensors record the ankle angle and velocity so that the assistive pattern can be analysed and personalised.



**03** Torque is applied at the ankle and this, researchers say, replaces some of the function of the calf muscle. The device gives a push off just before the toes leave the ground.

# Team Pinball

The thrill of pinball, plus the chance to plot a brand-new game, came together nicely with the help of Raspberry Pi. **Rosie Hattersley** hears how



**MAKER** János Kiss, Otília Pasaréti, and Romain Fontaine

Team Pinball was founded in 2016 by pinball enthusiasts and open-source advocates János, Otília, and Romain.

[teampinball.com](http://teampinball.com)

**T**eam Pinball is the UK’s only pinball design-and-build company. Based in Wales – pretty near to the Raspberry Pi factory, by coincidence rather than design – the trio behind Team Pinball come from Hungary and France, and are firm believers in all things open-source. Having seen the success of RetroPie gaming and how well it uses the capabilities of Raspberry Pi, the founders set about designing a new generation of pinball machines.

“Raspberry Pi is a powerful tool that has already found its place in the video game community with RetroPie. We wanted to do the same and create new, fun games with the Raspberry Pi,” explains Romain Fontaine. When the team sat down to decide on the theme and title for their pinball

“ The pinball table brings the player back to Chicago and the 1930s Prohibition Era with gangsters, casinos, and a bank to rob ”

machine, it became clear they were all fond of games from the 1980s era. Their retro game, The Mafia, “brings the player back to Chicago and the 1930s Prohibition Era with gangsters, casinos, and of course, a bank to rob!”

## Pi-eyed

Team Pinball originally designed their game for Raspberry Pi 2, noting its compact size and price and that it had “everything we needed”, including being able to output audio, drive the screen, and control the machine through its



Their friend Attila Szabo created the striking graphics, while Balint Ats's simulation helped check the gameplay worked as it should

GPIO,” says Romain. Having been updated and upgraded in the five years since Mafia Pinball launched to some acclaim in the pinball enthusiast arena, The Mafia is now based on a Raspberry Pi 3 that runs game code on top of a modified Linux image optimised for fast boot and low latency. There are two separate sets of software. One runs the game logic that reads the switches located in the machine and drives the solenoids and light show; the other plays music and audio effects, and also renders the score and animations on the LCD screen.

## Starting from scratch

Team Pinball designed the game and cabinet themselves, basing it on their own sketches, cutting playfields, wiring harnesses, and the electronic controller. The game’s pinball layout is their own design too, while most of the pinball-specific parts, such as mechanisms, are standard and can be bought on pinball websites. As far as possible, parts were locally sourced: the wooden

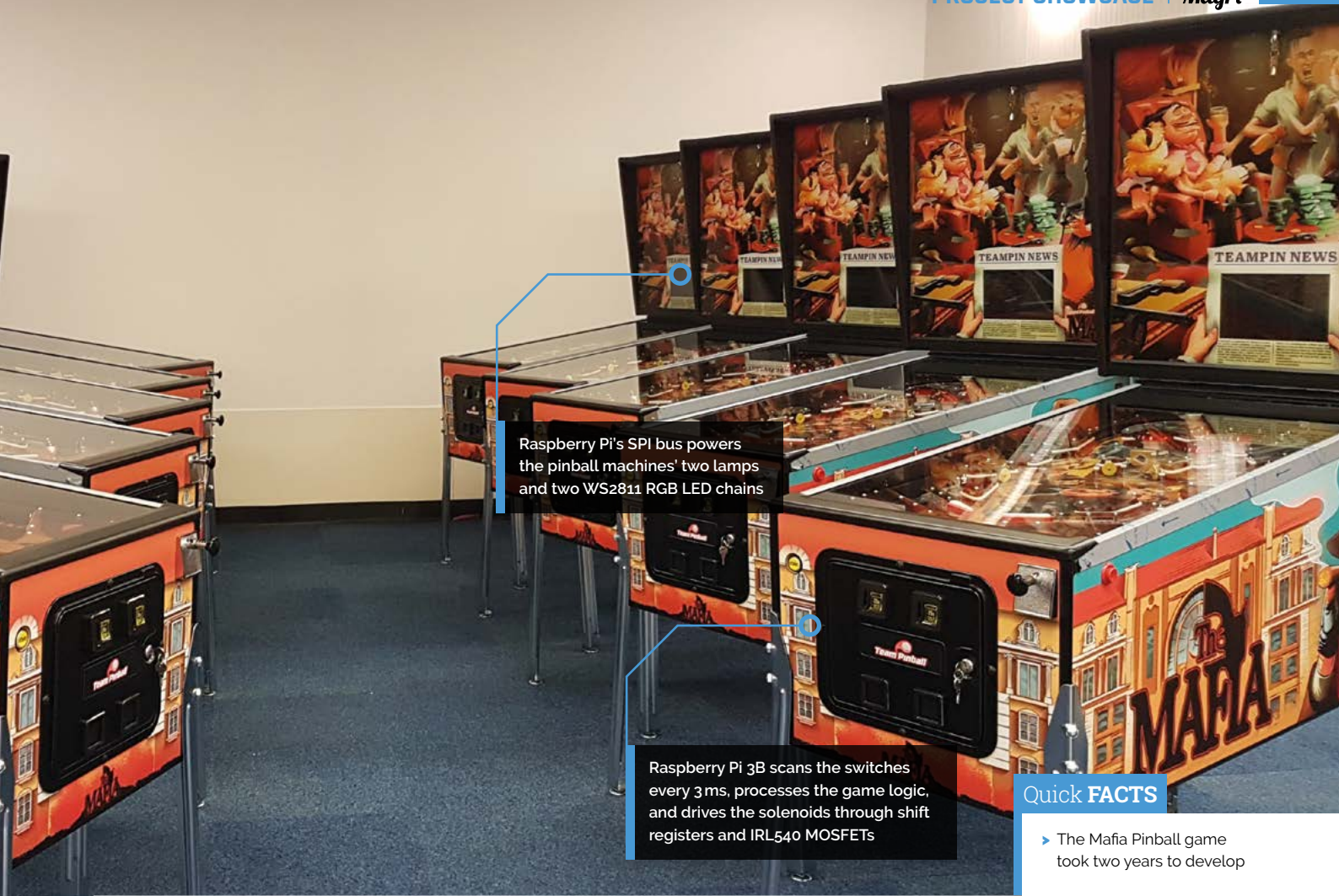

Raspberry Pi's SPI bus powers the pinball machines' two lamps and two WS2811 RGB LED chains

Raspberry Pi 3B scans the switches every 3 ms, processes the game logic, and drives the solenoids through shift registers and IRL540 MOSFETS

**Quick FACTS**

- ▶ The Mafia Pinball game took two years to develop
- ▶ The first prototype machine cost around £10,000
- ▶ A virtual simulator was used to check the layout and gameplay
- ▶ Issues included metric-manufactured European parts and imperial pinball parts
- ▶ And a 32-tonne truck delivering them all to their rural office



▲ Final assembly complete, Romain applies the Team Pinball logo



- ▲ Team Pinball commissioned Balint Arts to create the distinctive graphics and decals for the game
- ◀ Flippers, lights, and other standard pinball parts provide a familiar gaming experience

cabinet was made by a Welsh company, with printing and glass panels also done in Wales. “Our office is only 30 minutes away from Raspberry Pi’s factory,” says Romain, so they can also count that as a locally sourced part.

Team Pinball designed their own controller board, called Rboard, specifically for Raspberry Pi that is compatible with direct switches, as well as a switch matrix with up to 100 switch inputs. “It can drive more than 200 LEDs and 48 solenoids. This is more than previous pinball controllers such as the WPC, while using one tenth of the board space thanks to Raspberry Pi,” says Romain. “Several revisions” to the Rboard added a watchdog circuit to protect the hardware, capacitors, “and a regulator to maintain a perfect 5V for Raspberry Pi.” The latest version includes a DAC for improved audio quality. Video needed to be in H.264 format, so they had to find alternative rendering techniques.

Manufacturing was measured in a combination of metric for bespoke parts and imperial for standard pinball parts, which added to the challenge – not least because some of the manufacturers had never worked on a pinball machine before. When the 32-tonne lorry





delivering everything to Team Pinball's HQ arrived, turning down the narrow Welsh lane was a feat too far, so Romain and his colleagues had to carry the cabinets for the last part of their journey in the pouring rain. Nonetheless, everything was assembled and comprehensively checked before Mafia Pinball eventually made its much-anticipated debut.

The game has been a big hit in the pinball community, gaining numerous plaudits and orders. Their machines have shipped globally, to USA, Canada, Sweden, France, Austria, and even Australia. A Canadian company also uses the Team Pinball system for their game design. Better yet, Romain says Team Pinball "absolutely!" has more pinball machines in the pipeline. "More pinball projects, all powered with Raspberry Pi, CM4, and Raspberry Pi Pico!" [📄](#)

▲ With commissions to create machines for others, each machine is handmade by Team Pinball

## Get pinning

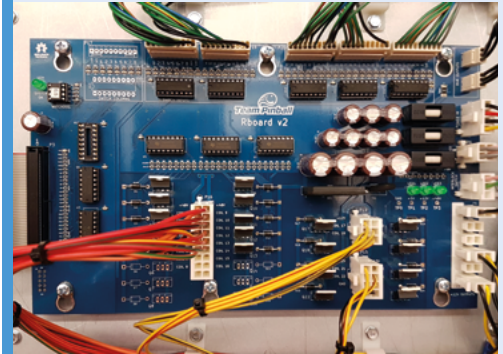

**01** If you want to make your own pinball machine, there are plenty of options. Team Pinball's controller is open-source, and can be found on GitHub: [magpi.cc/rboardgit](https://github.com/magpi.cc/rboardgit). Romain also suggests [pinballmakers.com](https://pinballmakers.com) as a good place to start.

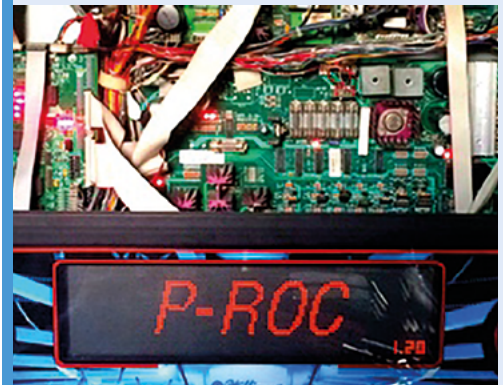

**02** A good knowledge of Python is useful for coding your own pinball machine. Alternatively, you could use code from [missionpinball.org](https://missionpinball.org) to either run software on an old pinball machine or for a brand-new one.

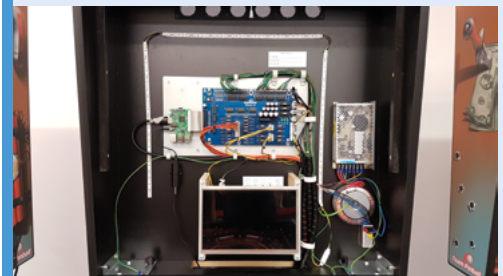

**03** Low latency to ensure rapid flipper response is vital. Along with a lightweight Linux image, Team Pinball uses C/C++ "to communicate with the GPIO pins for the best performance."

# Photon: A DIY incident light meter

You can make your own must-have photography tool with a Raspberry Pi Pico for a fraction of big-name prices. **Nicola King** prepares for her mugshot



**MAKER**  
Martin Spendiff & Vanessa Bradley

Martin is a mathematical modeller who left the UK for Switzerland, and a fan of FOSS and tech that serves users, rather than the people who made it. Vanessa is new to coding and a constant source of weird and good ideas.

veeb.ch

**W**hether you own a digital camera or an older one that uses film, a key piece of equipment for any photography enthusiast is an incident light meter. If you're unfamiliar with the concept, incident metering basically helps a photographer get the correct exposure for their images, measuring the amount of light falling onto a subject before they take a shot. Too much light gives you a white frame, while too little creates an image overly dark, and so the use of a light meter can vastly improve the quality of your photos.

## Pico power

While most modern digital cameras have light meters built-in, many older cameras don't have this luxury, and the price of some light meters can be prohibitive. Enter Martin Spendiff and Vanessa Bradley, two familiar makers who present their latest Pico-based project: Photon, a very budget-friendly take on this handy tool. Always keen to use old tech whenever possible, and aware of a revival using analogue film, the pair show off their make in this slick YouTube video: [magpi.cc/photonyt](https://magpi.cc/photonyt).

The duo felt that "the big brand light meters seemed too expensive for what they actually are." Also, this is a potential money-saver if you use film in your camera, as "film is still pretty expensive, so something that means more consistent images is really useful." Furthermore, Martin is now very conscious that, "after using Picos for a while, you look at things and think 'I could build that!'"



Photon contains a light sensor which reads the light level and then "does a little bit of calculation to make it able to turn that into the required camera settings. Pico is doing all the hard work with a bit of MicroPython that we put on GitHub ([magpi.cc/photongh](https://magpi.cc/photongh))," explains Martin. The code was "borrowed from some other projects (coffee grinder augmentation and the burger cooker); it isn't very complicated code, so it was pretty easy to cobble together."

## Proof of the pudding

To make sure that Photon was performing as it should, a consistency check was done against much more expensive counterparts, and the results were hugely encouraging. So much so that Martin admits being surprised: "When I saw that people were saying they were building them, I nervously went back and rechecked against a couple of



A Pimoroni BH1745 light sensor is located on the top of the meter

Press the button to take a reading, which is then shown on the OLED screen

Raspberry Pi Pico is enclosed in the light meter's 3D-printed case

#### Quick FACTS

- ▶ Martin and Vanessa spent around two months on Photon...
- ▶ The project cost them under \$50
- ▶ You can 3D-print an enclosure to hold all of the hardware together
- ▶ Photon currently measures ambient light brightness, along with RGB components
- ▶ Improvement-wise, "making something that works with studio lights would be a useful refinement"

“Film is still pretty expensive, so something that means more consistent images is really useful”

expensive meters and a grey card and a camera... it was accurate over a wide range of light levels. It was a relief!

“The feedback has largely been from the analogue film community, and positive,” he continues. “I think the overlap between makers and keen photographers is bigger than we anticipated.” Martin alludes to a famous photography expression, attributed to the New

York photographer Weegee, which is ‘f/8 and be there’, the underlying gist of which is: take the opportunity for a great picture, but don’t worry too much about technique, using a basic aperture setting. “The incident meter is a good way to simplify the process of getting a good exposure. My photos aren’t better, but they are definitely more consistent,” affirms Martin.

Regular readers of *The MagPi* will remember other Veeb projects we’ve featured, and Martin thinks he may now want to go back and “refactor” some of those soon. “There have been lots of times where we learned things and thought... we should have done X like that,” and Photon might be a project that gets some future refactoring once more GitHub feedback is received. You can find their collection of superbly put together and illuminative videos on Veeb’s YouTube page:

[magpi.cc/veebyoutube](https://magpi.cc/veebyoutube)

# Odyssey Lights

Blackpool's world-famous illuminations provided the setting for an interactive project that features Raspberry Pi. **Rosie Hattersley** gets enlightened



**MAKER**  
**Lorraine Underwood/  
 Jack Irving/  
 Sam Nugent  
 / Lightworks  
 NugentLightworks**

Lorraine Underwood is a senior teaching associate and PhD student at University of Lancaster; Sam Nugent is a Computer Science student; Jack Irving is an installation artist; Lightworks make Blackpool Illuminations.

[lorraine.mcunderwood.org](http://lorraine.mcunderwood.org)

**W**intertime illuminated walks and interactive art shows have proved extremely popular over the past few years. Blackpool's Odyssey lights combine the two, adding to the appeal of the renowned annual Blackpool Illuminations with impressive large-scale installations that respond to and even follow visitors as they explore the brightly lit site.

Odyssey is the brainchild of Lightworks, which creates and manages the existing Blackpool Illuminations attraction, Blackpool-born costume designer Jack Irving ([jackirving.co.uk](http://jackirving.co.uk)), and Lancaster University's School of Computing and Communications. The research team there led by Joe Finney, Professor of Computer Science, includes Raspberry Pi enthusiast and *The MagPi* regular Lorraine Underwood, a Senior Teaching Associate of Creative and Applied Computing. They had worked with Lightworks before to produce interactive displays, "but this is our first proper huge-scale project together," she explains.

## Enormous and ambitious

"All three organisations use, and create, cutting-edge technology for the public, and were keen to create something new and exciting for the public to enjoy," says Lorraine. Jack specialises in creative productions that fuse technology

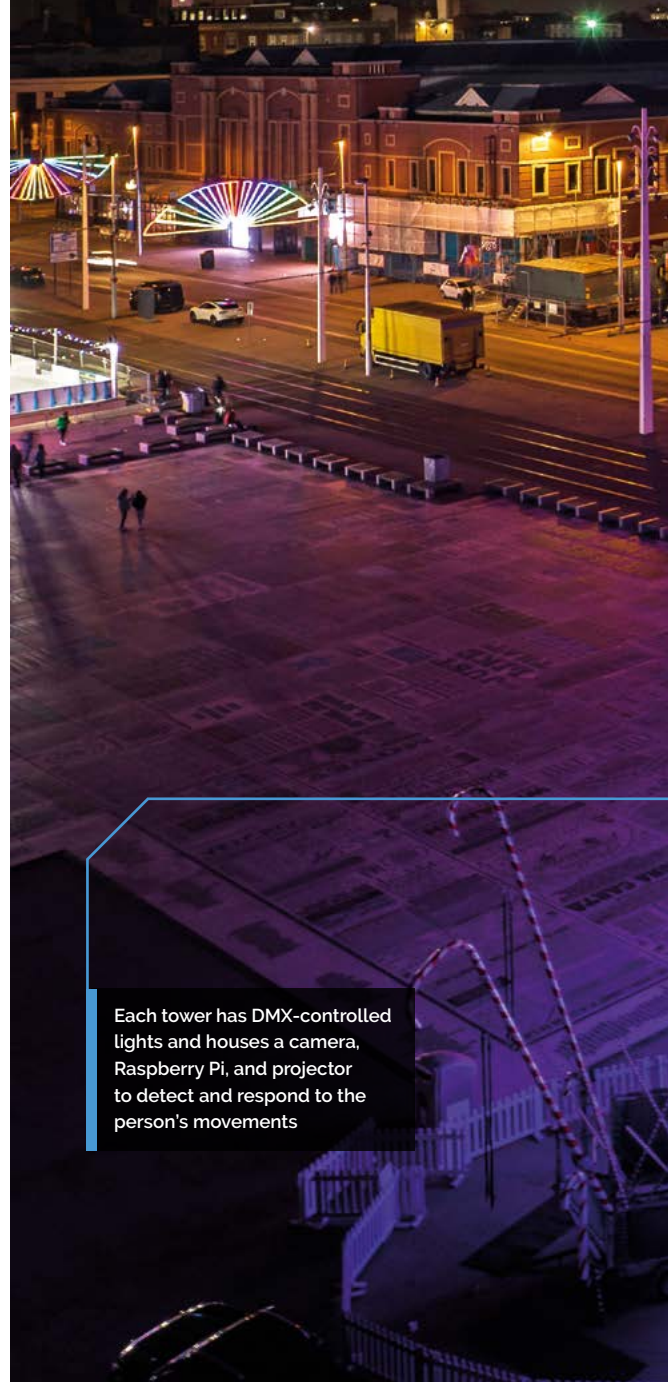

Each tower has DMX-controlled lights and houses a camera, Raspberry Pi, and projector to detect and respond to the person's movements

and fashion. Odyssey hoped to harness this to "engulf the world in the most fantastical spectacle." They began by co-designing and storyboarding, resulting in a vision for a series of 11-metre-tall towers featuring lasers, lights, speakers, and fog machines, each housing a projector and a camera. The six towers would project a ten-minute interactive show with different scenes containing alien sea creatures along an 18-metre path.

Cameras detect people along the path while each of the fantastical creatures behaves differently around them. "Some creatures would avoid people; some of them would follow you; others would swim together or appear when they detect a person nearby," says Lorraine.

"All the designs came from Jack Irving's unique style and imagination. It amazed me that



More than 3500 metres of lighting is used in the six 11-metre towers to ensure Odyssey is an impressive interactive experience

Computer vision algorithms are used to create interactions for the people strolling along Odyssey's walkway

**Quick FACTS**

▶ Huge automated drills were used to carve each creature's shape from polystyrene blocks, before sculptural elements were refined



- ▶ Odyssey plans began in 2019, but were delayed by Covid
- ▶ Each tower houses a Panasonic 12,000 lumen projector, Raspberry Pi, and camera
- ▶ The interactive displays required 10,000 lines of code
- ▶ There are 2400 LED nodes and over 3500 metres of LED lighting
- ▶ All of the lights are individually controllable



- ▲ The sculptures tower above participants walking along the installation's 18-metre walkway
- ▶ Odyssey being assembled at the Lightworks factory



Lightworks were able to create his designs in fibreglass at such a height," she adds.

### Technical challenges

"The Odyssey team needed a unique set of technologies for this project," explains Lorraine. "While the towers are huge, there's limited space inside them for equipment alongside all of the LED strips." They needed a small camera with strong video streaming capabilities, but it was also vital to minimise latency so the creatures would react in real-time to the audience.

Lorraine is the maker in the Lancaster University team and often uses Raspberry Pi in her projects, so she was confident in recommending it for the Odyssey. It transpired that Lightworks also knew Raspberry Pi well: some of the Blackpool Illuminations are controlled by Raspberry Pi too. Although accustomed to large-scale projects, testing the full Odyssey setup was challenging. They took over two lecture theatres at the University of Lancaster for the entire summer, but this had a ceiling only 3m high. The Lightworks building,

meanwhile, is tall enough to accommodate trucks, but the skylights weren't ideal for trialling something intended to be seen at night. "The cameras were calibrated using QR codes on the ground, which are difficult to see in sunshine." There was a final obstacle once Odyssey was unveiled. Several of the cameras fell victim to the "unforgiving" Blackpool wind and weather, necessitating a switch to USB cameras with sturdier protection. The results, however, are stunning.

“ Wherever you look while standing inside Odyssey, something amazing is happening ”

“Every time you walk through Odyssey, different creatures appear and act differently,” explains Lorraine. “We wanted to create an intense experience in every sense. The colossal 11-metre-high towers, the sound system, smoke machines, and lasers would complement the interactive projection show on the ground. Wherever you look while standing inside Odyssey, something amazing is happening.”

The team insisted on making Odyssey adaptable – the setup can be easily configured to use fewer cameras and projectors – while plans are afoot to make it easy to load different graphics and scenes into the projection show, ensuring many more marvels to come. [M](#)

▼ The scale of the creatures becomes clear when laid out on the Lightworks factory floor



## Interactive light show



**01** There are six cameras with viewing angles that overlap the six projections. The cameras take photos continuously and feed images to computer vision algorithms which inform the content of the projection.



**02** Since the idea is to respond to the participant, constantly updating the person's position and movements is critical to Odyssey appearing to mimic them. The calibration process was rather complex.



**03** OpenCV homography matrices calibrate each camera to its adjacent projector. The calibration information is then translated between the camera coordinates and projector coordinates. Working out how it works was a challenge!

# PaperPi V3

Whizz-bang technology is all very impressive but, as a consumer, it's also exhausting. **Rosie Hattersley** was delighted to hear of a more subtle Raspberry Pi-based approach



**Aaron Ciuffo**

MAKER

A lifelong maker and hardware hacker Aaron taught himself Python after getting a book recommendation on Slashdot.

[magpi.cc/paperpigitt](http://magpi.cc/paperpigitt)

**S**ometimes it seems as though everyday technology and media is getting progressively brighter, louder, and more in-your-face, with every second advertising hoarding being an interactive TikTok experience.

PaperPi is intended as a tonic to all that, with its maker billing the combination of Raspberry Pi and e-paper screen device as a “quiet internet radio.” With our eyes, ears, and attention in constant demand from screens and speakers, the idea of a more relaxing reading and listening experience chimes with our craving for peacefulness and time to think. Now in its third iteration, PaperPi is “a lovely, quiet, slow internet e-paper radio [that] rotates through your choice of plug-in screens at the pace you choose,” according to its inventor, Aaron, in his summary YouTube video ([magpi.cc/paperpiyt](http://magpi.cc/paperpiyt)).

## Early promise

As with so many of our featured project showcase makers, Aaron showed a very early interest in electronics and technology. “When I was eight, I disassembled the TV remote and (poorly) punched holes through the faceplate so I could add ‘extra features’,” he relates. “I lovingly remember this as my first successful hack, even if it was awful and ugly.”

▼ A possible use for PaperPi is as a dementia clock, gently informing someone of the time with no harsh LEDs



PaperPi also came about as the result of a hack: Aaron’s initial goal was to replace the failing display on a Logitech Squeezebox media player with “something more visually pleasing.” The LED screen should have shown the currently playing tracks or, when nothing was playing, the time. Aaron had “never been terribly fond of the aesthetic of the blue-green LEDs of the matrix screen” and the Squeezebox’s “decidedly early aughts [noughties] black and silver package.” With the screen failing, he saw an opportunity to replace it.

## Elegant understatement

Aaron says Raspberry Pi driving an e-paper screen was perfect for his project. “As an added bonus, it was easy to add a HiFiBerry [DAC] and use Raspberry Pi for playing music directly into the stereo amplifier.” Aaron has been a Raspberry Pi convert since acquiring a Model A when backing the Kano kit on Kickstarter, and being charmed by the possibilities of its GPIO pins and blinking LEDs. “Raspberry Pi really is amazing because it combines the openness of the enormous Linux community and a massive, and generally

“ PaperPi is deliberately quiet and unobtrusive ”

affordable, hardware ecosystem” – and a great match for his Squeezebox replacement.

Aaron borrowed some of the logic and layout from VEEB’s Stonks ([magpi.cc/stonksgit](http://magpi.cc/stonksgit)) and Edify ([magpi.cc/edifygit](http://magpi.cc/edifygit)) projects, and was keen to emulate their clean and tidy look. “Ideally, the screen would be easy to read from across the room, look great, but also fade into the room.” He definitely didn’t want “loud colours, bright lights, animations, or anything distracting.” Instead, he devised PaperPi around a Waveshare e-paper display and ensured it shows only what interests the user, such as moon phases. Although it is theoretically limited to Waveshare screens,



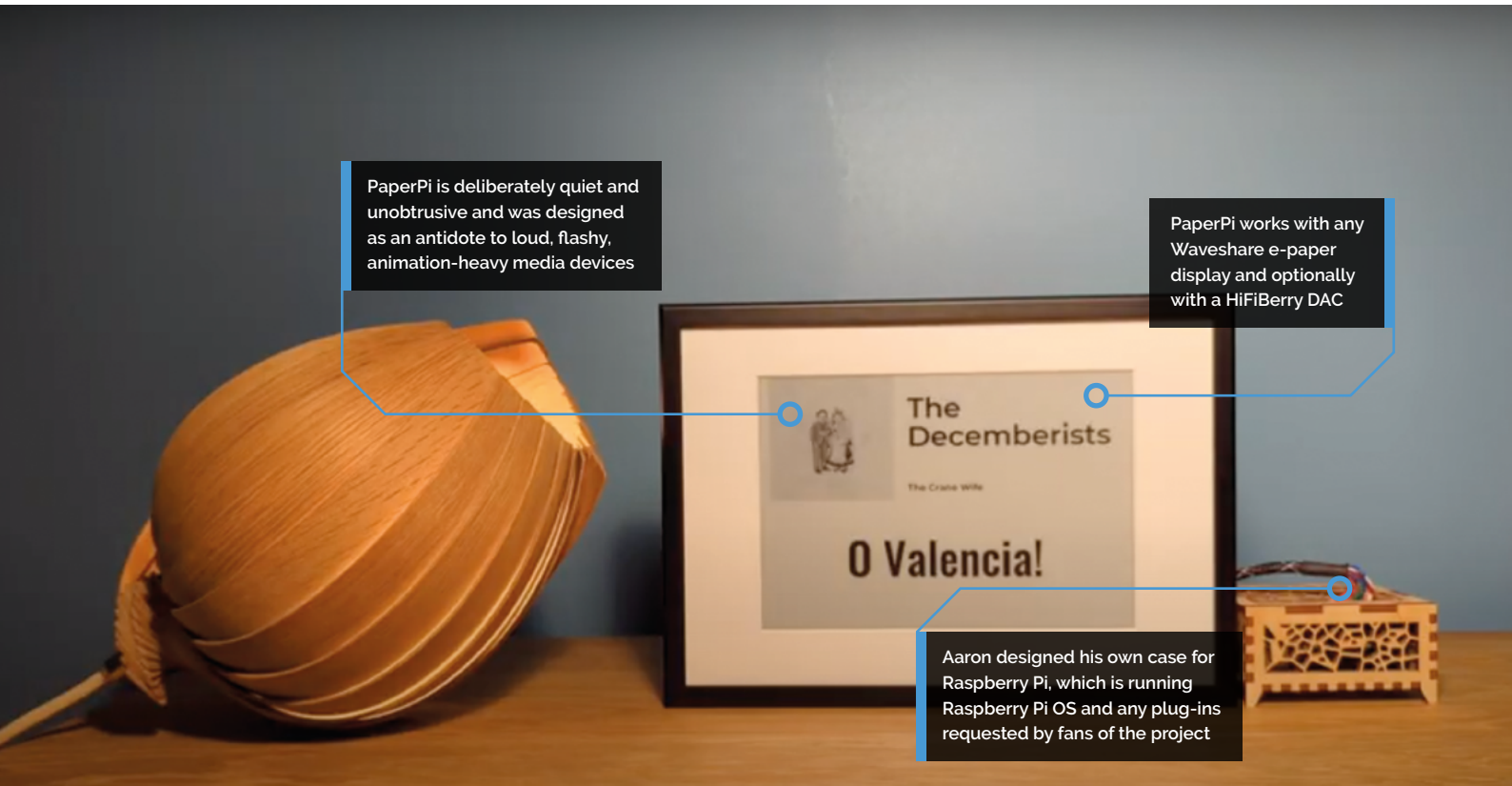

PaperPi is deliberately quiet and unobtrusive and was designed as an antidote to loud, flashy, animation-heavy media devices

PaperPi works with any Waveshare e-paper display and optionally with a HiFiBerry DAC

Aaron designed his own case for Raspberry Pi, which is running Raspberry Pi OS and any plug-ins requested by fans of the project



- ◀ PaperPi's resolution adapts to the available screen and is ideal for slideshows
- ▼ Adding a DAC to the PaperPi means it can play music through this stereo amplifier, making it more like a media streamer

**Quick FACTS**

- ▶ Aaron credits epdlib with helping address some tricky display issues
- ▶ PaperPi works with Raspberry Pi 3, 4, and Zero
- ▶ It can be used on any Waveshare-based e-paper display
- ▶ The plug-in scales the output to match any screen size
- ▶ Logitech Media Server and Spotify plug-ins are also supported

Aaron has written a number of plug-ins that allow his epdlib-based code to be used for different purposes, most recently as a digital photo frame. Since he can often adapt an existing plug-in, he can usually “crank out” a new plug-in in a weekend. He would also love to develop PaperPi for other makes of screen. “I haven’t worked the drivers into the project yet, but it is something I would love some help with if anyone is interested!”

Quizzed over the biggest design challenge, Aaron replies: “font choices: clashing descenders and ascenders!” He now has “so much more appreciation for why late 1990s Windows installations had a fit when I tried to change system fonts.” [M](#)

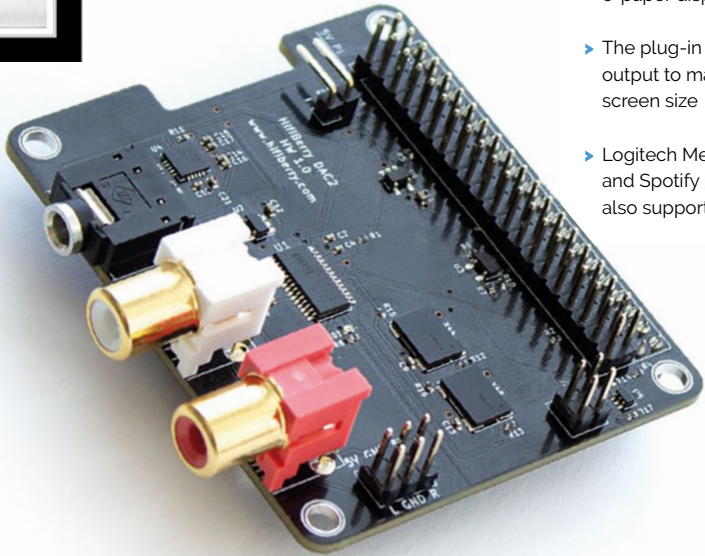

# SUBSCRIBE TODAY FOR JUST £10

Get 3 issues + FREE Pico W



## Subscriber Benefits

- ▶ **FREE Delivery**  
Get it fast and for FREE
- ▶ **Exclusive Offers**  
Great gifts, offers, and discounts
- ▶ **Great Savings**  
Save up to 35% compared to stores

## Subscribe for £10

- ▶ Free Pico W
- ▶ 3 issues of The MagPi
- ▶ Free delivery to your door
- ▶ £10 (UK only)

## Subscribe for 6 Months

- ▶ Free Pico W
  - ▶ 6 issues of The MagPi
  - ▶ Free delivery to your door
- |          |                     |
|----------|---------------------|
| £30 (UK) | £35 (USA)           |
| £35 (EU) | £45 (Rest of World) |

☎ Subscribe by phone: **01293 312193**

📧 Subscribe online: **magpi.cc/subscribe**

✉ Email: **magpi@subscriptionhelpline.co.uk**

Subscribe for £10 is a UK-only offer. The subscription will renew at £15 every three months unless cancelled. A free Pico W is included with a 6-month subscription in USA, Europe and Rest of World.

SUBSCRIBE TODAY AND GET A

# FREE Raspberry Pi Pico W

Subscribe in print today and get a **FREE** development board

- ▶ A brand new RP2040-based Raspberry Pi Pico W development board
- ▶ Learn to code with electronics and build your own projects
- ▶ Make your own home automation projects, handheld consoles, tiny robots, and much, much more



This is a limited offer. Not included with renewals. Offer subject to change or withdrawal at any time.



Buy now: [magpi.cc/subscribe](https://magpi.cc/subscribe)

**SUBSCRIBE**  
on app stores

From **£2.29**

Available on the  
**App Store**

GET IT ON  
**Google Play**

# INTRODUCING CAMERA MODULE 3

FOUR BRAND-NEW CAMERA OPTIONS WITH SUPER-FAST AUTOFOCUS AND HIGHER QUALITY IMAGES. **LUCY HATTERSLEY** TAKES A SNAPSHOT OF CAMERA MODULE 3

**W**e're off to a fantastic start for 2023 with Raspberry Pi releasing a vastly improved Camera Module 3 ([magpi.cc/cameramodule3](http://magpi.cc/cameramodule3)) and the new Raspberry Pi HQ Camera - M12 mount ([magpi.cc/hqcamera](http://magpi.cc/hqcamera)).

Camera Module 3 brings lightning-fast autofocus, HDR, and an improved 12-megapixel sensor to Raspberry Pi. Meanwhile, the Raspberry Pi HQ Camera - M12 mount opens up the High Quality Camera to M12 lenses that previously required an adaptor to work.

All the cameras are supported by libcamera software, which now provides support for autofocus via Raspberry Pi's Open Source Camera System. There is also a new Picamera2 Python Library for controlling Camera Module 3 with Python code.

We're massive fans of Camera Module projects here at The MagPi, and this new Camera Module 3 enables vastly higher-quality shots that are super-sharp to look at. We can't wait to see what vision-based projects it helps you all bring to life.

Raspberry Pi cameras connect directly to the CSI (camera serial interface) socket on Raspberry Pi and bring vision, video, and photography projects to life. They are used in everything from home and outdoor photography to machine learning and keeping tabs on industrial production lines.

Raspberry Pi has taken an interesting tack with Camera Module 3 by augmenting the regular version with a Wide model. These join the normal and NoIR (no infrared) options making for a grand total of four Camera Module 3 models to choose from.

Camera Module 3 Wide has an expanded 120° field of view (up from the 75° on the regular version).

The Raspberry Pi HQ Camera - M12 mount vastly increases the range of lenses that are compatible with the high-quality camera. M12 is a 12mm mount that is widely used in industrial environments. It was previously possible to use M12 lenses with the HQ Camera with CS mount, and this new camera removes the need for an adaptor making it more cost-effective.

▼ Camera Module 3 and Camera Module HQ connect directly to Raspberry Pi via a ribbon cable

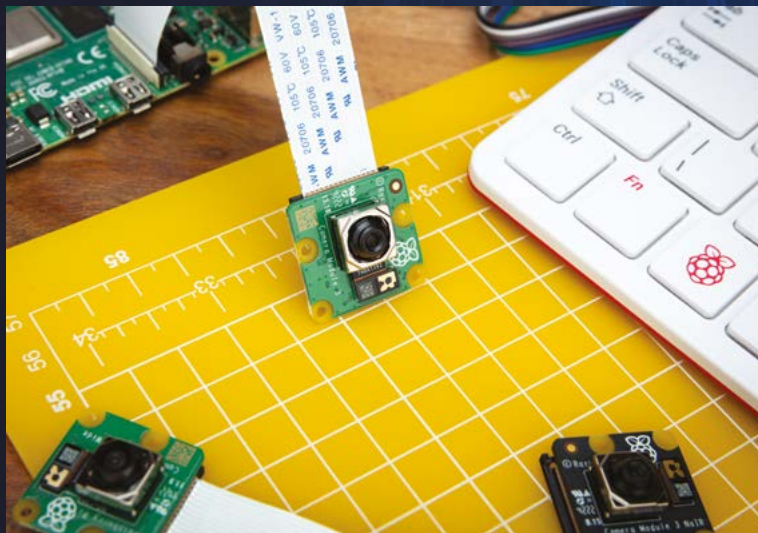

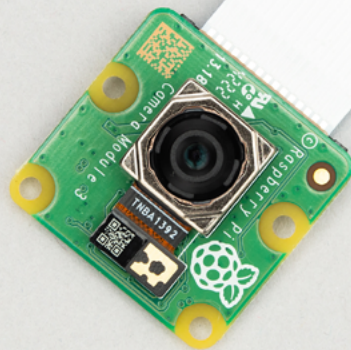

## CAMERA OPTIONS

There are NoIR options for both the Camera Module 3 and Camera Module 3 Wide versions. NoIR cameras have had the infrared sheet removed which allows infrared light to reach the

Camera Module 3 features an up-to-date image sensor from Sony designated IMX708

lens. Images taken with NoIR cameras in regular daylight may look strange, but infrared enables you to capture a dark scene that is lit up with infrared light (which can't be seen by humans or animals). NoIR cameras are perfect for filming animals in dark or low-light conditions.

Camera Module 3 features an up-to-date image sensor from Sony designated IMX708. This is a 12-megapixel camera meaning images contain a total of 12 million pixels. This kind of pixel density produces an incredibly detailed and high-quality image, and 12 million pixels is capable of producing very high-quality images like those used in professional photography cameras.

## GET IN FOCUS

Another new feature is HDR (High Dynamic Range). HDR shots have vastly improved colour range, with darker blacks and lighter whites. The produced images have a smaller resolution (comprising of 3-megapixel) and look amazing. The other marquee feature is autofocus which makes its way to Camera Module 3 alongside software support from libcamera. The autofocus is lightning fast and you can control what Camera Module 3 focuses on in software and code. The latest version of Raspberry Pi OS comes with a beta of Picamera2, a Python library developed by Raspberry Pi that is perfect for everything from snapping images to building advanced image recognition applications.

Camera Module 3 joins Camera Module 2 and the board outline and mounting holes are in the same position. Many makers can swap out Camera Module 2 for Camera Module 3 with one caveat: the lens itself protrudes further out so any casing that restricts the lens will need upgrading. Camera Module 3 is available from official Raspberry Pi resellers.

▲ Camera Module 3 and Camera Module 3 NoIR

# MEET THE FOUR NEW CAMERA 3 MODELS

## CAMERA MODULE 3

**PRICE:**  
\$25  
**FIELD OF VIEW:**  
75°  
**INFRARED FILTER:**  
Yes (regular use)



## CAMERA MODULE 3 NOIR

**PRICE:**  
\$25  
**FIELD OF VIEW:**  
75°  
**INFRARED FILTER:**  
No (see in the dark  
with infrared light)



## CAMERA MODULE 3 WIDE NOIR

**PRICE:**  
\$35  
**FIELD OF VIEW:**  
120°  
**INFRARED FILTER:**  
No (see in the dark  
with infrared light)



## CAMERA MODULE 3 WIDE

**PRICE:**  
\$35  
**FIELD OF VIEW:**  
120°  
**INFRARED FILTER:**  
Yes (regular use)

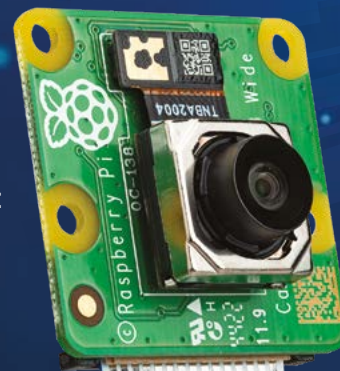

# GET TO KNOW CAMERA MODULE 3

## 1 SENSOR

Camera Module 3 comes with a 7.4 mm diagonal Sony IMX708 12-megapixel sensor offering higher resolution photographs than the 8-megapixel sensor in the camera it replaces (and a vast improvement on the 2-megapixel sensor in the original camera).

## 2 FORM FACTOR

The form factor of the board remains identical to Camera Module 2, meaning that most projects will be upgradable by simply swapping out the camera. Note that the sensor protrudes slightly more, so it might not fit if there is housing around the lens.

## 3 NOIR

A NoIR (no infrared) option is available for both the regular and wide-angle variants. This has the infrared filter removed (this typically sits in front of the lens). Allowing infrared light into the lens makes daylight photos look strange, but it gives you the ability to see in the dark with infrared lighting. This is ideal for night wildlife photography because infrared light does not startle animals.

## 4 AUTOFOCUS

Fresh to Camera Module is an I2C-controlled focus actuator. This enables Camera Module 3 to focus incredibly quickly on the subject.

## 5 RIBBON CABLE

Camera Module connects directly to Raspberry Pi boards via the CSI (Camera Serial Interface) connector. This ribbon cable connects the camera directly to the board.

## 6 REGULAR / WIDE LENS

There are both regular and Wide options available. The regular Camera Module 3 has a 75-degree diagonal angle of view, while Camera Module 3 Wide variant has a 120-degree angle.

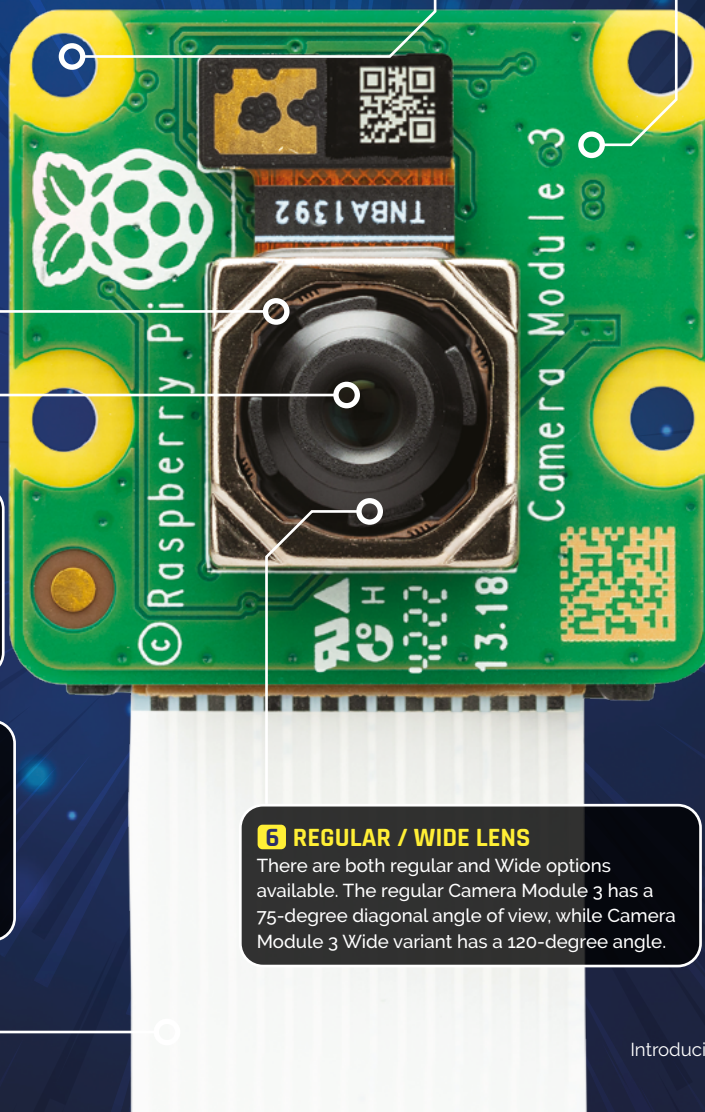

## CAMERA MODULE 3 KEY FEATURES

- Price: \$25/\$35
- Sony IMX708 12-megapixel sensor
- Autofocus via I2C-controlled focus actuator controlled by libcamera
- HDR Mode (in 3-megapixel mode)
- Large 7.4 mm diagonal sensor
- 75-degree diagonal angle of view on regular camera; 120-degree angle on Wide versions
- Compatible with all models of Raspberry Pi (except Raspberry Pi 400; Raspberry Pi Zero models require a special camera cable).

# WHAT IS HDR?



HDR (High Dynamic Range) is a new addition to Camera Module 3. HDR is used to describe images that have a wide range of brightness values, from very dark to very bright. This allows for more detail and more accurate representations of the scene to be displayed.

In photography, HDR techniques can be used to merge multiple exposures of the same scene to create a single image with a wider dynamic range. HDR is used to improve the contrast and colour reproduction of the image and HDR images captured by Camera Module 3 look fantastic.

▲ A HDR photograph of Ely taken with Raspberry Pi Camera Module 3 Wide

## HDR EXAMPLES

The images show how HDR is used to vastly improve the quality of shots.



Interior underexposed to capture exterior detail



Interior correctly exposed; exterior detail blown out



Tone-mapped HDR image captures both interior and exterior detail





▲ This shot was taken without HDR enabling the autofocus to work much faster

## AUTOFOCUS

Camera Module 3 features ultra-fast autofocus as standard. A rich library of libcamera software commands enables you to have total control over what you focus on and how you do it. Watch the Camera Module 3 autofocus video on YouTube ([magpi.cc/cam3autofocusdemo](https://magpi.cc/cam3autofocusdemo)).



## COMPARING CAMERAS

	 Camera Module 1	 Camera Module 2	 Camera Module 3	 Camera Module 3 wide	 HQ Camera
<b>Net price</b>	\$25	\$25	\$25	\$35	\$50
<b>Size</b>	Around 25 × 24 × 9 mm	Around 25 × 24 × 9 mm	Around 25 × 24 × 11.5 mm	Around 25 × 24 × 12.4 mm	38 × 38 × 18.4 mm (excluding lens)
<b>Weight</b>	3g	3g	4g	4g	37.8g
<b>Still resolution</b>	5 Megapixels	8 Megapixels	11.9 Megapixels	11.9 Megapixels	12.3 Megapixels
<b>Video modes</b>	1080p30, 720p60 and 640 × 480p60/90	1080p47, 1640 × 1232p41 and 640 × 480p206	2304 × 1296p56, 2304 × 1296p30 HDR, 1536 × 864p120	2304 × 1296p56, 2304 × 1296p30 HDR, 1536 × 864p120	2028 × 1080p50, 2028 × 1520p40, 1332 × 990p120
<b>Sensor</b>	OmniVision OV5647	Sony IMX219	Sony IMX708	Sony IMX708	Sony IMX477
<b>Sensor resolution</b>	2592 × 1944 pixels	3280 × 2464 pixels	4608 × 2592 pixels	4608 × 2592 pixels	4056 × 3040 pixels
<b>Sensor image area</b>	3.76 × 2.74 mm	3.68 × 2.76 mm (4.6 mm diagonal)	6.45 × 3.63mm (7.4 mm diagonal)	6.45 × 3.63mm (7.4 mm diagonal)	6.287 mm × 4.712 mm (7.9 mm diagonal)
<b>Pixel size</b>	1.4 μm × 1.4 μm	1.12 μm × 1.12 μm	1.4 μm × 1.4 μm	1.4 μm × 1.4 μm	1.55 μm × 1.5 μm
<b>Optical size</b>	1/4 inch	1/4 inch	1/2.43 inch	1/2.43 inch	1/2.3 inch
<b>Focus</b>	Fixed	Adjustable	Motorized	Motorized	Adjustable
<b>Depth of field</b>	Approx 1meter - ∞	10cm - ∞	10cm - ∞	5cm - ∞	N/A
<b>Focal length</b>	3.60 mm (+/- 0.01mm)	3.04 mm	4.74 mm	2.75 mm	Depends on lens
<b>Horizontal field of view</b>	53.50 +/- 0.13 degrees	62.2 degrees	66 degrees	102 degrees	Depends on lens
<b>Vertical field of view</b>	41.41 +/- 0.11 degrees	48.8 degrees	41 degrees	67 degrees	Depends on lens
<b>Focal ratio (F-Stop)</b>	2.9	2	F1.8	F2.2	Depends on lens
<b>Maximum exposure times (seconds)</b>	6	11.76	60	60	670.74

## WHAT TO MAKE WITH CAMERA MODULE 3

The Raspberry Pi camera can be used for a variety of projects. Here are some projects you can make with it:

- 1. Home security:** Camera Module 3 can be used to create a DIY home security system by setting up the Raspberry Pi to take photos or record video when motion is detected.
- 2. Time-lapse photography:** Raspberry Pi's camera can be set up to take photos at regular intervals, which are combined into a time-lapse video.
- 3. Wildlife photography:** The camera can be used to set up a remote wildlife camera to capture photos or videos of animals in their natural habitat.
- 4. Industrial inspection:** The camera is used to inspect industrial equipment or machinery. This could be for quality control and maintenance purposes.
- 5. Astrophotography:** Raspberry Pi camera is used in astrophotography projects, photographing celestial objects and keeping an eye on meteorites.
- 6. Art projects:** The Raspberry Pi camera can be used in art projects, such as creating interactive installations or using it as a tool for digital photography.

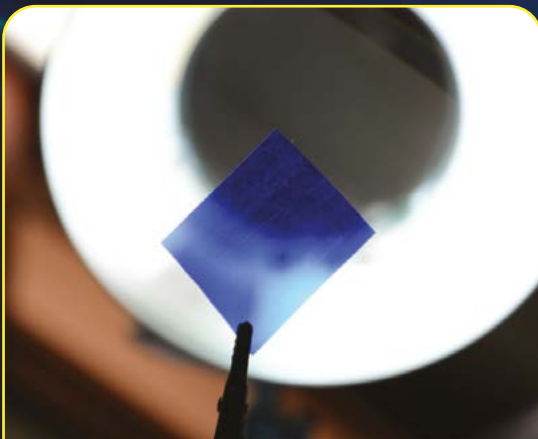

## WHAT'S THE BLUE THING?

If you pick up a Raspberry Pi Camera Module 2/3 NoIR, you'll notice a small blue piece of blue gel in the box. It turns out a lot of botanists use Raspberry Pi Camera to check in on the health of trees. One way is to check for 'greenness', but a better way is to use the NoIR camera with this blue gel to check for infrared and not blue. Raspberry Pi's Director of Communications, Liz Upton has written a fascinating article that explains all: [magpi.cc/bluething](http://magpi.cc/bluething).

## GET STARTED WITH CAMERA MODULE 3

Camera Module 3 takes advantage of the Raspberry Pi Open Source Camera System powered by libcamera. This rich set of libraries gives developers precise control over image processing and better access to the internals of Camera Module 3.

The latest version of Raspberry Pi OS comes pre-installed with a beta of Picamera2, a Python library developed here at Raspberry Pi in Cambridge. For beginners and advanced users alike, Picamera2 is perfect for everything from home projects to machine-learning applications.

Raspberry Pi Camera Module documentation with setup instructions can be found on Raspberry Pi's website.

[magpi.cc/camgetstarted](http://magpi.cc/camgetstarted)

**Getting Started**

Using the camera for the first time

**NOTE**

On Raspberry Pi 3 and earlier devices running Bullseye you need to manage GPIO in order to make the Pi hardware hardware discoverable and camera window work. To do this you need to enable I2C at boot and then choose advanced options, Enable and Yes. If you're not using I2C you can skip this step and let it reboot your Raspberry Pi.

When running a Raspberry Pi OS based on Bullseye, the 3 basic libcamera apps are already installed. In this case, official Raspberry Pi cameras will also be detected and enabled automatically.

You can check that everything is working by entering:

```
lsmod | grep bcm2835
```

When running Bullseye will need to install one of the cameras, see [camgetstarted](http://magpi.cc/camgetstarted) for the full application notes for the connected camera. Be aware that cameras and the legacy raspicam still cannot operate at the same time. To return to the legacy mode when using libcamera you will need to comment out the `libcamera` change you made and reboot the system.

**NOTE**

Raspberry Pi 3 and other devices may not be default be using the camera. Double check you refer to the [libcamera](http://magpi.cc/camgetstarted) file and ensure that all of the above steps are followed in order to get the camera working.

If you do need to alter the configuration

You may need to alter the camera configuration in your `/boot/config.txt` file if:

- You are using a 3rd party camera (the manufacturer's instructions should explain the changes you need to make)
- You are using an official Raspberry Pi camera but wish to use a non-standard driver/library
- You are using an older version (buster or earlier) of the operating system (in which case we would recommend upgrading first if this is possible)

# RESOURCES

BOOKMARK THESE PAGES TO HELP YOU ON YOUR CAMERA JOURNEY

## RASPBERRY PI DOCUMENTATION - CAMERA

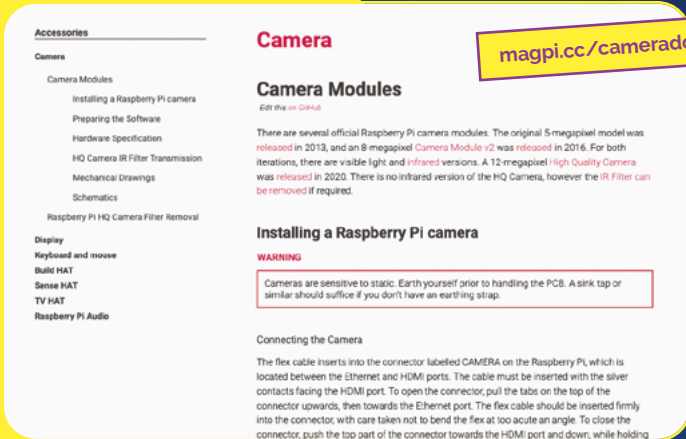

The screenshot shows the Raspberry Pi Camera documentation page. On the left is a navigation menu with categories like Accessories, Camera, Camera Modules, Display, Keyboard and mouse, Build HAT, Sense HAT, TV HAT, and Raspberry Pi Audio. The main content area is titled 'Camera' and includes sections for 'Camera Modules' (with a warning about static electricity), 'Installing a Raspberry Pi camera', and 'Connecting the Camera'.

[magpi.cc/cameradocs](https://magpi.cc/cameradocs)

## CAMERA MODULE 3 PRODUCT BRIEF



[magpi.cc/cam3docs](https://magpi.cc/cam3docs)

▼ Detailed documentation is available for Raspberry Pi Camera Module

## PICAMERA2 MANUAL

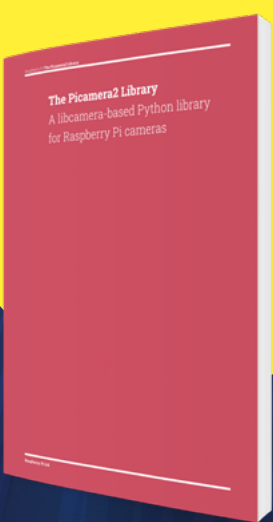

[magpi.cc/picam2docs](https://magpi.cc/picam2docs)

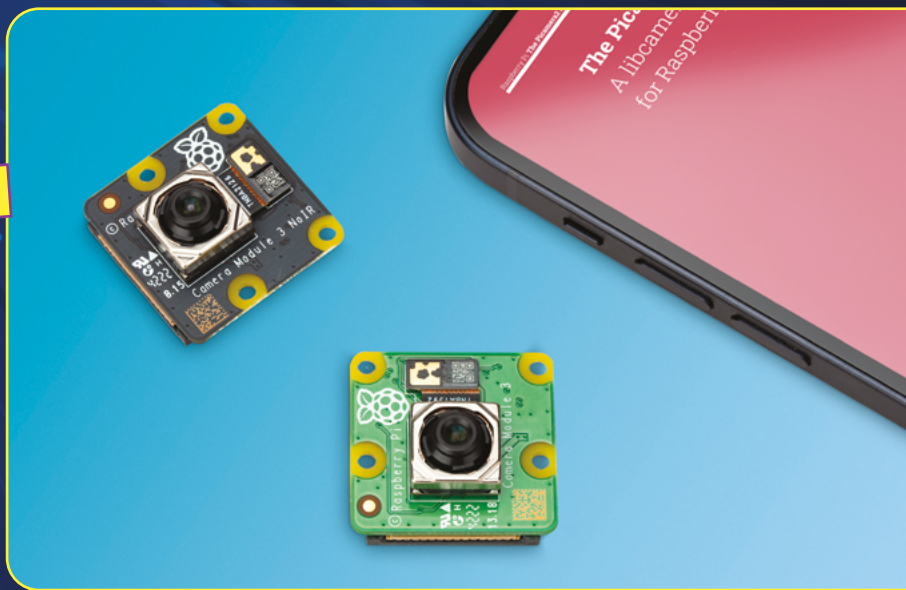

# RASPBERRY PI CAMERA MODULE 3 ENGINEERING Q&A



**Simon Martin**

Senior Principal Hardware Engineer at Raspberry Pi and designer of Raspberry Pi 400.

WE CATCH UP WITH **SIMON MARTIN**, SENIOR PRINCIPAL HARDWARE ENGINEER AT RASPBERRY PI

**C**amera Module 3 is “our latest generation of low-cost lightweight camera modules for general day and night time photography using your Raspberry Pi computer,” explains Simon Martin, Senior Principal Hardware Engineer at Raspberry Pi.

The big difference is the new Sony IMX708 camera at the heart. This is “the latest, most up-to-date sensor from Sony Imaging,” Simon tells us. It has a “12-megapixel sensor with built-in HDR for bright colourful photography and it supports autofocus directly from libcamera.”

“The more pixels in the camera, the more detail captured in the photograph,” says Simon. “However, to achieve this you need a better quality lens” and the Camera Module 3 has a lens upgrade that “can do justice to a 12-megapixel sensor.”

You can snap photos in regular or HDR mode. “Regular mode provides the most amount of pixels and optimises the performance of the autofocus system,” explains Simon. “HDR reduces

the resolution to 3-megapixels, but the colours are much more crisp, and light levels are adaptive across the image, so dark or shadowed objects are still clear in an image that is very bright elsewhere.”

## Getting into focus

The marquee feature for Camera Module 3 is the new autofocus mode. “By providing autofocus, we provide a much more flexible camera that can adapt to its surrounds to ensure it always provides a sharp focus.”

This update to Camera Module was “long overdue,” he tells us. “We have been making Camera Module 2 for six years now, and we have upgraded our libcamera software and we want a camera product that will do it justice.”

The new Wide lens option is “more suitable for security cameras where you need a wide field of view,” explains Simon. “It also has a better depth of field, and can focus on objects down to a distance of 5-6 mm from the lens.”

There is also a slightly improved F-stop number for Camera Module 3. It's now F1.8 which is slightly better than the F2 value for Camera Module 2. This enables Camera Module 3 to "collect slightly more light and so the exposure time is reduced."

As for upgrading: "The board outline and mounting holes are exactly the same as the Camera Module 2," explains Simon. "The optical centre of the lens is also in the same location. For many people, this means the camera will be a plug-in replacement. However, the larger module means that the camera is a little taller and so it will not fit into such tight spaces. An example of this is the Pi Zero case which does not provide enough height for it to fit."

### New M12 option

Alongside the Camera Module 3 is the new High Quality Camera - M12 mount. This "is a variant of the HQ camera that we have already been making for two-and-a-half years," says Simon. The M12 variant increases "the range of lenses that are compatible with the HQ camera." It was possible to use M12 lenses before with an adaptor, but this

Our latest generation of low-cost, lightweight camera modules

solution is simpler, cheaper, and is compatible with more lenses than using an adaptor.

The High Quality Camera - M12 mount camera "has been tested with a wide range of lenses," explains Simon. "The back focus thread length covers most M12 lenses. The exceptions are some

## GAOJIA M12 LENSES

Raspberry Pi has worked with Gaojia to test three M12 lenses that are recommended. These three lenses are:

- Telephoto (18° field of view)
- Portrait (56° field of view)
- Wide angle (120° field of view)

[magpi.cc/gaojialenses](http://magpi.cc/gaojialenses)

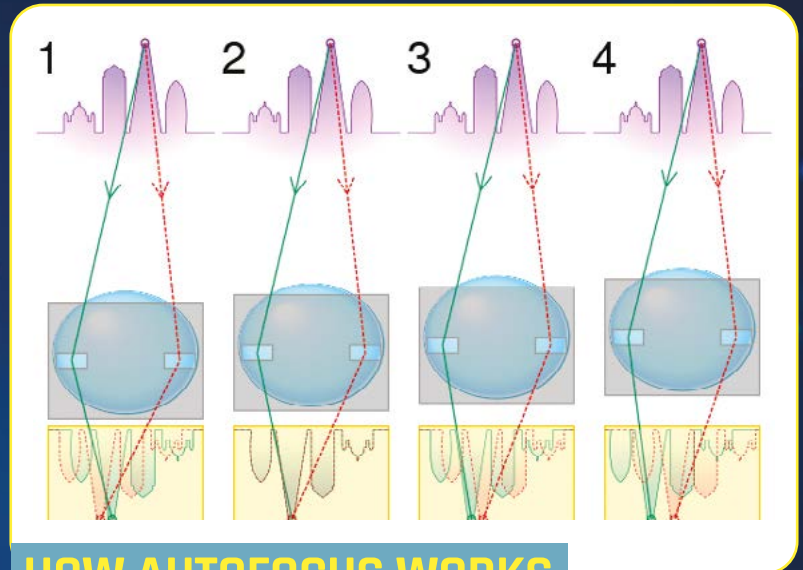

## HOW AUTOFOCUS WORKS

The camera sensor "uses PDAF (Phase Detect Auto Focus) to detect distance," explains Simon. "Some of the pixels can see either only the left or the right of the lens, and a parallax effect can be detected between them. The more parallax is detected, the closer the object is to the sensor. The lens is connected to a physical actuator that can move it nearer or further away from the sensor to adjust the focus. The actuator works in the same way as a loudspeaker coil and moves the lens forwards or backwards. A controller chip inside the Camera Module is used to drive the coil to the correct position. The chip takes its instructions from the ribbon cable using the I2C interface."

[magpi.cc/pdaf](http://magpi.cc/pdaf)

lenses that require a back focus position of less than 2mm. These are typically cheap fish-eye lenses that require the lens to be almost touching the sensor. Even if these lenses were made to work, the image is so badly vignetted that it appears as a small circle on the sensor.

"In order to minimise potential confusion of what lens fits your application, we have teamed up with a supplier called Gaojia that will provide three lenses that we have fully characterised and can recommend."

# Create an animation with Scratch



Phil King

A long-time contributor to *The MagPi*, Phil is a freelance writer and editor with a focus on technology.

@philkingeditor

## Top Tip

### Duplicate or delete

By right-clicking a single block, or the top of multiple connected blocks, you can opt to duplicate it, add a comment (to explain it), or delete it. Or you can simply drag blocks to the left of the coding area to delete them.

- ▶ Add another sprite for the dancer. We chose Jouvi Dance, as she has lots of 'costumes' showing her various dance moves

Get started with block-based programming and create a dance party

**Y**ou don't necessarily have to type lines and lines of code to create a computer program. With Scratch, you can build programs by connecting blocks together. Created by the boffins at MIT, no wonder Scratch is a favourite resource for teaching children how to start coding, as it's easy to learn and can be used to create all sorts of programs, animations, and games. There are lots of built-in graphics and backdrops to choose from, or you can create your own custom ones using Scratch's built-in graphics editor.

In this guide, we'll help you to get started with Scratch on Raspberry Pi by building a fairly simple interactive animation for a couple of sprites on the Scratch 'stage'. This will encompass using movement, sounds, speech bubbles, interactive clicks, loops, and costume switching to animate a dancer. Let's party!

## 01 Online or off

On a Raspberry Pi, you can either build your Scratch projects online at [scratch.mit.edu](https://scratch.mit.edu) (and create a free account) in the Chromium web browser, or in the Scratch 3 offline editor.



The latter is available under Programming in the Raspberry Pi OS applications menu (top left of the desktop) – if it's not installed already, go to Preferences > Recommended Software, tick the checkbox to the right of Scratch 3, and then click Apply. Once installed, it will appear in the applications menu.

Unless you want to use Raspberry Pi's GPIO pins, it doesn't really matter whether you create your project online or offline: the editor features are almost identical and you can save or load programs to and from your Raspberry Pi (or another computer) to use in either editor.

When the Scratch 3 offline editor launches, it will automatically create a new project. Alternatively, if using the online editor, click the Create option at the top.

## 02 New project

A blank Scratch project starts with the Scratch cat sprite on a blank backdrop, shown on the 'stage' at the top right – this area can be minimised or expanded to full screen. On the left are all of the standard Scratch blocks with which you can build programs. The middle area (currently blank) is where you will drag and drop blocks to create code.

Many Scratch tutorials start with deleting the cat, but as we're fond of felines, we're going to use the furry critter in this project! We renamed the sprite as 'Cat' in the 'Sprite' field for it (bottom right panel), but it doesn't really matter. We then dragged the sprite to the bottom left of the stage – you can see (and set) the exact x and y coordinates above the sprites panel.

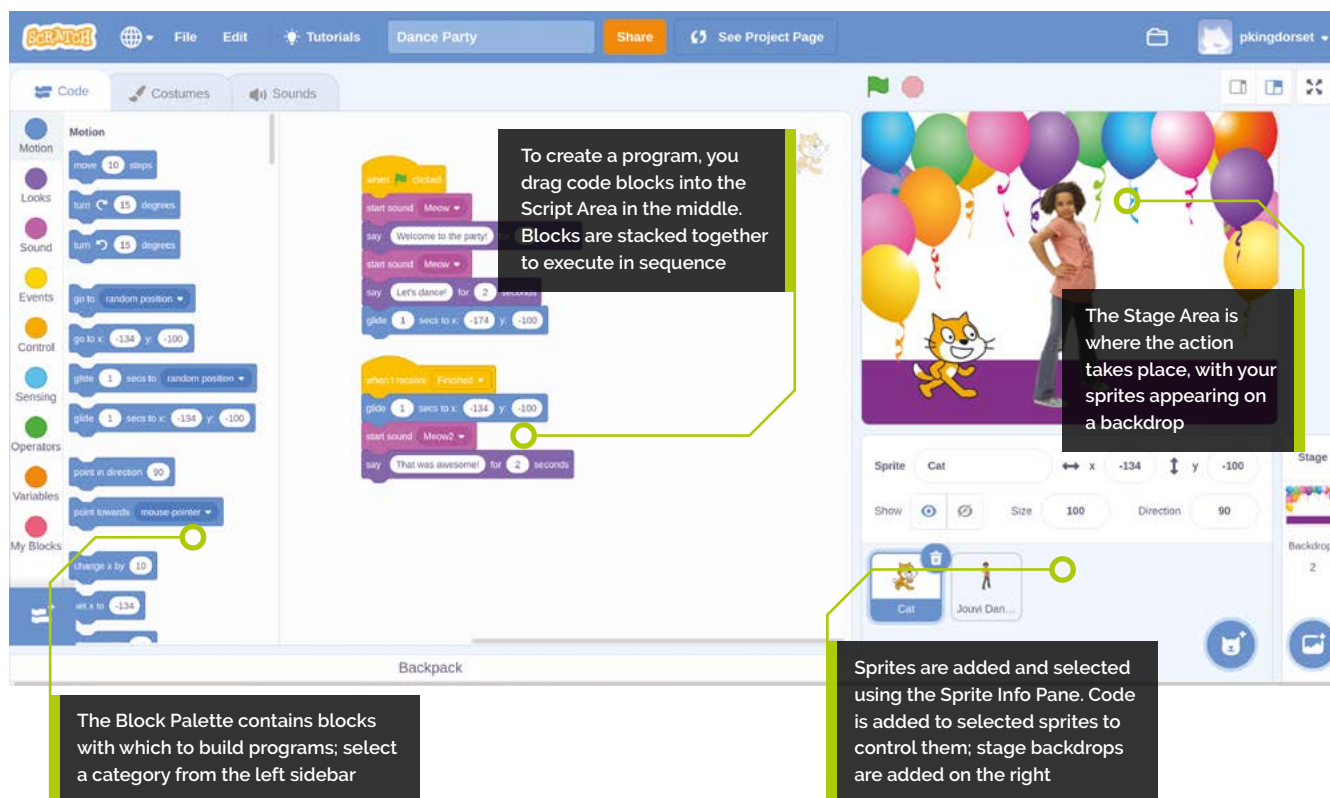

### 03 New background

That stage is looking a little dull – no place for a party – so let’s alter that. Click the ‘Choose a Backdrop’ icon at the bottom right. You’ll be presented with a gallery of all the built-in

“ There are lots of built-in graphics and backdrops ”

backdrops; to narrow it down, click the Indoors option at the top. We chose the Party backdrop for our project, but you may prefer another one – or to even paint your own in the graphics editor (select the Backdrops tab after clicking on the backdrop’s thumbnail at the bottom right). You can also import backdrops (as well as sprites) at a suitable resolution.

### 04 Add a sprite

It’s not much of a party with just one guest, so let’s add another sprite to our scene. Click the ‘Choose a Sprite’ icon at the bottom right of the sprite info pane. You’ll see a gallery of all the built-in sprites; select the Dance option at the top to narrow it down. We chose Jouvi Dance, but you might want a different dancer – you want one

with a good array of dance moves, though; hover the cursor over them to see all of their ‘costumes’ in sequence.

To give her room to dance, we’ll drag Jouvi Dance to the middle of the stage area. Now the scene is set, we can start coding to make something happen.

### 05 Start coding

First, let’s get our Cat to give the dancer an introduction. Each sprite (and backdrop) can have its own code, so make sure the Cat is selected in

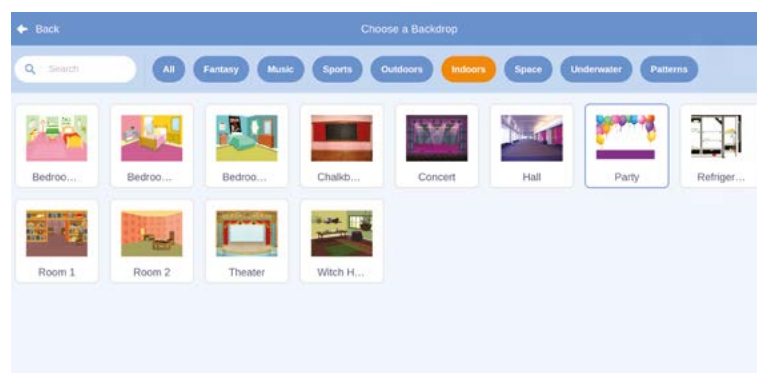

▲ Add a backdrop to the stage area for the dance party; you can even add multiple backdrops and switch between them



▲ Start coding the Cat. Drag blocks into the central area and connect them together into code scripts

the sprite info pane. Then click the yellow Events category on the far left and drag a 'when green flag clicked' block over to the central script area. This will tell the Cat what to do when we start the program by clicking the green flag.

Select the purple Looks category and drag a 'say Hello! for 2 seconds' block and place it directly under the 'when green flag clicked' block so it connects to it. Double-click the 'Hello' text in the block to change it by typing; we chose 'Welcome to the party!' You can change the duration by clicking on the '2', but we left it the same.

We then dragged another 'say Hello! for 2 seconds' block below the previous one and changed the text to 'Let's dance'. If you click the green flag to start the program, the Cat will now say the two phrases (in speech bubbles) in turn.

## 06 Set up the dancer

To animate a sprite in Scratch, you switch between its different costumes – Jovi Dance has 12 of them. Click on her thumbnail in the sprite

info pane to start coding. Since we don't want to start dancing straight away when the program is started, this time we'll drag a 'when this sprite clicked' Events block into the script area.

First, we'll get her to say something and then start the music. Drag a 'say Hello! for 2 seconds' Looks block and attach it to the bottom of the 'when this sprite clicked' block. We changed the text to 'Check this out!' and the duration to

## “ Let's animate her dance by cycling through her sprite costumes ”

1 second. Below it, add a 'start dance celebrate' Sound block to play the music.

## 07 Animate the dancer

Now let's animate her dance by cycling through her sprite costumes in turn. To do this, we need to create a finite repeating loop: drag a 'repeat 10' Control block to the bottom of your code; this will repeat any blocks within it that number of times.

While there is a 'switch costume' Looks block to change to a specific costume, to make it simpler we'll use a 'next costume' block to cycle through them all; drag this block into the 'repeat 10' loop. Without a delay, the program would cycle through them too quickly, so we need to add a 'wait 1 seconds' Control block underneath 'next costume' (and within the 'repeat 10' loop).

To fit the length of our music, we need to adjust the number of repeats and the wait time. We found that changing the '10' to 24 in the 'repeat' block and the '1' to '0.3' in the 'wait' block worked well.

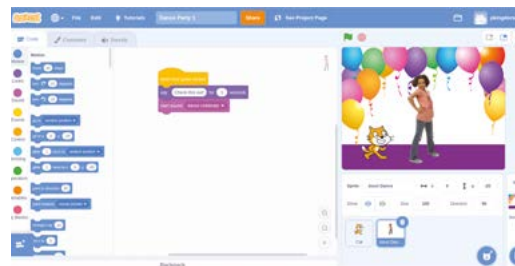

▲ Coding the dancer. We use a Sound block to start playing the music

## Top Tip

### More blocks

We've only scratched (sorry!) the surface with this project. Other block types in Scratch include Operators (for calculations and comparisons), Variables (to store values), and Sensing (for detecting key presses and sprite collisions etc.)

## Scratch projects

For more Scratch project ideas, visit the Raspberry Pi Projects site. There are projects of varying difficulty, including animations, games, and builds that use Raspberry Pi's GPIO header to control electronics.

[magpi.cc/scratchprojects](http://magpi.cc/scratchprojects)

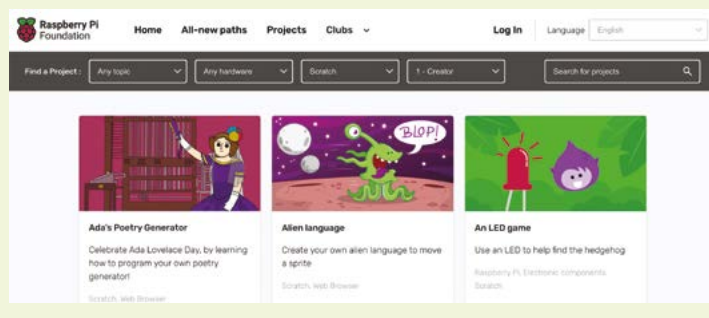



Now, when you click on the Jouvi Dance sprite, she will do her dance.

## 08 Finishing move

When she finishes the dance, she may end up with a different costume each time; to change it back to the original one, we can add a 'switch costume' block to the underside of the 'repeat' loop (not within it) and set it to 'jo stance'.

Let's also give her some appreciation from the crowd. Click the Sounds tab and then the 'Choose a Sound' icon to see all the built-in sounds. Search for 'Cheer' and select it. Back in the Code tab, add a 'start sound' block to the bottom of the code and change it to 'Cheer'.

## 09 Final touches

Maybe our Cat would like to say something after the dance. To trigger this, we can add a 'broadcast' Events block to the bottom of the Jouvi Dance code; this will send a message that can be received by the code for other sprites. You can create a new name for it, by clicking the drop-down and selecting 'New message'; we called ours 'Finished'.

In the Cat code, add a 'when I receive Finished' Control block. Under it, add a 'say Hello! for 2 seconds' block and change the text to 'That was awesome!' (or whatever you like).

We also added a 'Meow2' sound to go with it, and added 'Meow' sounds before the Cat's other 'say' blocks in the original code. In addition, we used 'glide 1 seconds to x: y:' blocks in both parts of the Cat's code to make it step back before the dance and then forward again afterwards.

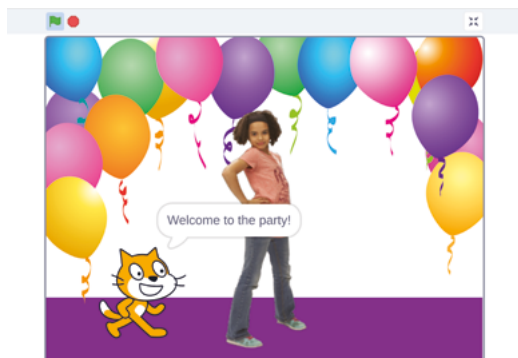

▲ You can make the stage full-screen for a better view of your interactive animation

## Cat

Language: **Scratch**

**DOWNLOAD THE FULL CODE:**

 [magpi.cc/github](https://magpi.cc/github)

```

when clicked
  start sound Meow
  say Welcome to the party! for 2 seconds
  start sound Meow
  say Let's dance! for 2 seconds
  glide 1 secs to x: -174 y: -100

when I receive Finished
  glide 1 secs to x: -134 y: -100
  start sound Meow2
  say That was awesome! for 2 seconds
  
```

## Jouvi Dance

Language: **Scratch**

```

when this sprite clicked
  say Check this out! for 1 seconds
  start sound dance celebrate
  repeat 24
    next costume
  wait 0.3 seconds
  switch costume to jo stance
  start sound Cheer
  broadcast Finished
  
```

Congratulations! You've created an interactive animation. You could extend it by adding another dancer, using 'move' or 'glide' blocks to move them around the stage, or even have them compete in a dance-off. [M](#)

## Top Tip

### Add extensions

By clicking the icon at the bottom left, you can add extensions to Scratch for more block types, such as Music, Pen, and – on Raspberry Pi – GPIO for connecting electronics.

# Create a toy Chatter Box with Raspberry Pi Codec Zero



**Toby Roberts**

Toby used to work for the police. Now he is Maker in Residence at Raspberry Pi. Laser cutting and 3D printing are his favourites. Free merch hoarder!

[raspberrypi.com/tutorials](http://raspberrypi.com/tutorials)

MAKER

Use the new Raspberry Pi Codec Zero audio board to build a Chatter Box that records and plays back five-second audio clips

**A**s an example of what Raspberry Pi audio boards can do, let's walk through the creation of a toy Chatter Box. Its on-board microphone, programmable button, and speaker driver make the Codec Zero an ideal choice for this application.

A random pre-recorded five-second audio clip will be played when the button is pressed. After holding it for ten seconds, a notifying burp sound will be emitted, after which a new five-second clip will be recorded. Holding the button down for more than 20 seconds will play a second burp sound, and then erase all previous recordings.

## 01 Hardware and wiring

For this project, any small passive speaker should be sufficient. We're using a 3-inch one which handles 5W of power at 4Ω. We have also used an illuminated momentary push-button, and a laser-cut box to house all the components, but both are entirely optional.

This example will work just using the Codec Zero's on-board button, which is pre-wired to GPIO 27. (Alternatively, you can use any momentary push-button, such as those available here: [magpi.cc/miniarcadebutton](http://magpi.cc/miniarcadebutton).)

Use a small flat-head screwdriver to attach your speaker to the screw terminals. For the

additional push-button, solder the button wires directly to the Codec Zero pads as indicated, using GPIO pin 27 and GND (ground) for the switch, and +3.3V and GND for the LED, if necessary. See **Figure 1** for the wiring diagram.

## 02 Setting up your Raspberry Pi

In this example, we are using Raspberry Pi OS Lite. Our getting started guide covers this topic in great detail ([magpi.cc/installingtheos](http://magpi.cc/installingtheos)). Make sure that you update your operating system before proceeding and follow the instructions provided for Codec Zero configuration, including the commands to enable the on-board microphone and speaker output.



▲ Pressing the button to record and play back audio

### You'll Need

- ▶ Raspberry Pi Zero [magpi.cc/zero2w](http://magpi.cc/zero2w)
- ▶ 3-inch speaker [magpi.cc/3inchspeaker](http://magpi.cc/3inchspeaker)
- ▶ Mini Arcade Button [magpi.cc/miniarcadebutton](http://magpi.cc/miniarcadebutton)

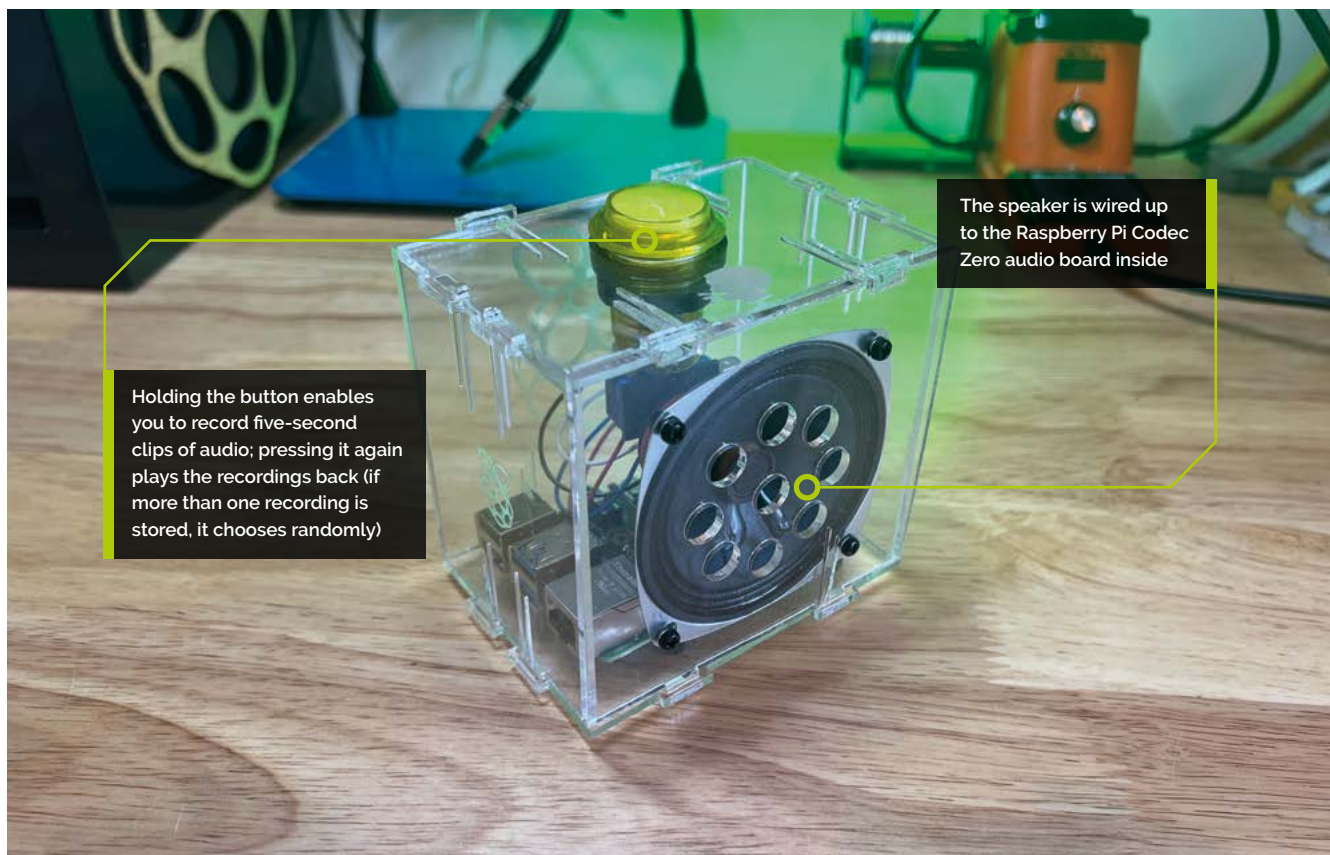

Holding the button enables you to record five-second clips of audio; pressing it again plays the recordings back (if more than one recording is stored, it chooses randomly)

The speaker is wired up to the Raspberry Pi Codec Zero audio board inside

### 03 Programming your Raspberry Pi

Open a shell – for instance by connecting via SSH – on your Raspberry Pi and run the following to create our Python script:

```
sudo nano chatter_box.py
```

Add the code from `chatter_box.py` to the file and press **CTRL+X**, then **Y** and **ENTER** to save.

### 04 Make the script executable

To make the script executable, type the following:

```
sudo chmod +x chatter_box.py
```

Enter the following to create a crontab daemon that will automatically start the script each time the device is powered on:

```
crontab -e
```

You will be asked to select an editor; we recommend you use nano. Select it by entering the corresponding number, and press **ENTER** to continue. The following line should be added to the bottom of the file:

```
@reboot python /home/pi/chatter_box.py
```

Press **CTRL+X**, then **Y** and **ENTER** to save, then reboot your device.

### 05 Operating your Chatter Box

The final step is to ensure that everything is operating as expected. Press the button and release it when you hear the burp. The recording

### Top Tip

Watch the burp

When you press and hold the button, it will download and play the `burp.wav` file to let you know it's ready to record.

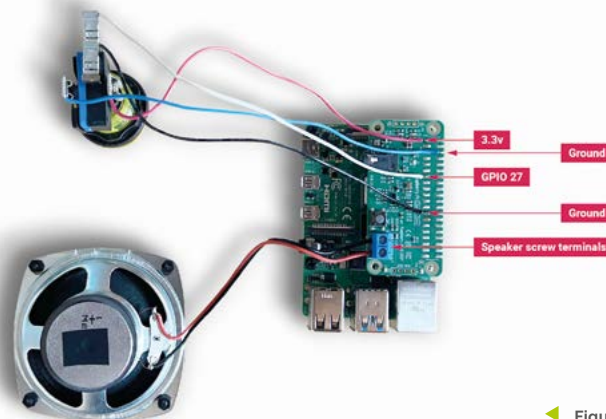

 **Figure 1** The wiring for our Chatter Box

## chatter\_box.py

DOWNLOAD  
THE FULL CODE:

 [magpi.cc/chatterboxpy](https://magpi.cc/chatterboxpy)

> Language: Python 3

```

001. #!/usr/bin/env python3
002. from gpiozero import Button
003. from signal import pause
004. import time
005. import random
006. import os
007. from datetime import datetime
008.
009. # Print current date
010.
011. date = datetime.now().strftime(
012.     "%d_%m_%Y-%H:%M:%S")
013. print(f"{date}")
014. # Make sure that the 'sounds' folder exists, and
015. # if it does not, create it
016. path = '/home/pi/sounds'
017.
018. isExist = os.path.exists(path)
019.
020. if not isExist:
021.     os.makedirs(path)
022.     print("The new directory is created!")
023.     os.system('chmod 777 -R /home/pi/sounds')
024.
025. # Download a 'burp' sound if it does not already
026. # exist
027. burp = '/home/pi/burp.wav'
028.
029. isExist = os.path.exists(burp)
030. if not isExist:
031.     os.system('wget http://rpf.io/burp -O burp.wav')
032.     print("Burp sound downloaded!")
033.
034. # Setup button functions - Pin 27 = Button hold
035.
036. button = Button(27, hold_time=10)
037.
038. def pressed():
039.     global press_time
040.     press_time = time.time()
041.     print("Pressed at %s" % (press_time));
042.
043. def released():
044.     release_time = time.time()
045.     pressed_for = release_time - press_time
046.     print("Released at %s after %.2f seconds" %
047.         (release_time, pressed_for))
048.     if pressed_for < button.hold_time:
049.         print("This is a short press")
050.         randomfile = random.choice(os.listdir(
051.             "/home/pi/sounds/"))
052.         file = '/home/pi/sounds/' + randomfile
053.         os.system('aplay ' + file)
054.     elif pressed_for > 20:
055.         os.system('aplay ' + burp)
056.         print("Erasing all recorded sounds")
057.         os.system('rm /home/pi/sounds/*');
058.
059. def held():
060.     print("This is a long press")
061.     os.system('aplay ' + burp)
062.     os.system('arecord --format S16_LE --duration=5
063.         --rate 48000 -c2 /home/pi/sounds/$(date +"%d_%m_%Y-
064.         %H_%M_%S")_voice.m4a');
065.
066. button.when_pressed = pressed
067. button.when_released = released
068. button.when_held = held
069.
070. pause()

```

will now begin for a period of five seconds. Once you have released the button, press it briefly again to hear the recording. Repeat this process as many times as you wish, and your sounds will be played at random. You can delete all recordings by pressing and holding the button, keeping the button pressed during the first burp and recording process, and releasing it after at least 20 seconds, at which point you will hear another burp sound to confirm that the recordings have been deleted.

## 06 Next steps

Upgrades! It is always fun to upgrade a project, so why not add some additional features, such as an LED that will illuminate when recording? This project has all the parts required to make your own version of a Google intelligent speaker system ([magpi.cc/aiyprojects](https://magpi.cc/aiyprojects)), or you may want to consider building a second device that can be used to create a pair of walkie-talkies that are capable of transferring audio files over a network via SSH. 

# English not your mother tongue?

The MagPi is also available in German!



Subscribe to the German edition of The MagPi and get a Raspberry Pi Pico with headers and a cool welcome box **FOR FREE!**

Use the coupon code **115PicoDE** on [www.magpi.de/115](http://www.magpi.de/115)



# Build a Raspberry Pi Flight Tracker



**Toby Roberts**

Toby used to work for the police. Now he is Maker in Residence at Raspberry Pi. Laser cutting and 3D printing are his favourites. Free merch hoarder!

[raspberrypi.com/tutorials](http://raspberrypi.com/tutorials)

Keep an eye on planes with a Raspberry Pi radio to scan aircraft frequencies

**Y**ou can create all kinds of fun projects when you pair a Raspberry Pi with a low-cost USB software-defined radio (SDR).

An SDR is essentially a radio wave receiver that can pick up signals from a variety of frequencies, such as digital television and AM, FM, and DAB radio broadcasts. This tutorial will focus on the information transmitted by the transponders installed on aircraft flying overhead using Automatic Dependent Surveillance–Broadcast (ADS–B). These avionics systems provide information to identify aircraft, as well as their barometric altitude, to the air traffic control (ATC) systems on the ground and to the traffic collision avoidance systems (TCAS) on other aircraft. Listening in to these signals provides a fascinating insight into a world we all take for granted.

Raspberry Pi 3 Model A+ is perfect for this project as it has a single USB–A port, which is all we need, and our very best on–board Wi–Fi. We’re also going to team up with other SDR and aviation enthusiasts and contribute to Flightradar24, which operates the world’s largest network of ADS–B/Mode S receivers. This network, together with government air traffic control and other data sources, is how Flightradar24 is able to track

aircraft around the globe. In other words, this is plane spotting – on steroids.

## 01 Choose your kit

This project will work on any Raspberry Pi 3 or newer model. For this tutorial, we are using a Raspberry Pi 3 Model A+. Projects like these are often left powered for long periods of time, so it’s important to have a good-quality power supply for your Raspberry Pi. We recommend the official USB power supplies ([magpi.cc/usbpower](http://magpi.cc/usbpower)), as they are designed to provide a consistent +5.1V with captive (that is, attached) USB cables.

For the USB ADS–B receiver, you can buy any RTL2832/R820T2–based USB dongle that’s available to you locally, or from your favourite online retailer. Prices usually start around \$20.

## 02 Your usual computer

You’ll also need another computer connected to your network. We’ll refer to this as ‘your usual computer’, to distinguish it from a Raspberry Pi computer that you are setting up for our flight tracker. We’re going to be accessing and controlling our Raspberry Pi via Wi–Fi from this computer, so there is no need for an additional keyboard, mouse, and display to be attached to your Raspberry Pi: this is called a headless setup.

## 03 Installing Pi24

Download a pre–prepared Raspberry Pi operating system image from Flightradar24 at [magpi.cc/buildpi24](http://magpi.cc/buildpi24) by clicking on the blue ‘Download Pi24’ button.

▼ The Pi24 operating system image is provided by Flightradar24

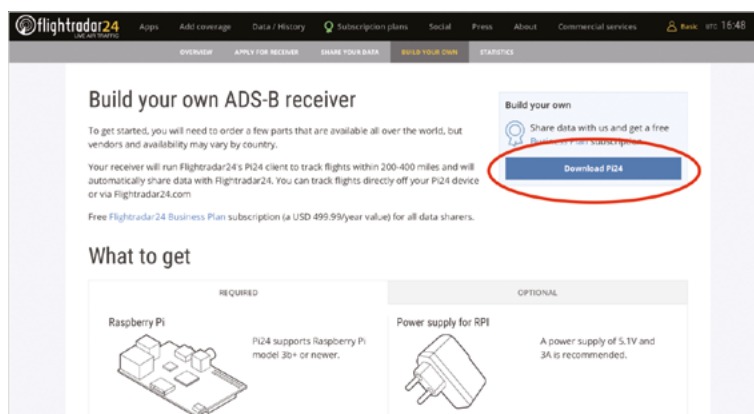



Raspberry Pi 3A+ is a low-cost board with a single USB port that makes it ideal for this project

This USB software-defined radio (SDR) is used to detect the information from flight transponders

There are other ADS-B services that offer similar custom OS packages – e.g. FlightAware, ADS-B Exchange, and RadarBox – that will let you build an ADS-B ground station. We picked one here for the tutorial, but if you want to use one of the others, the procedure is going to look very similar. After installation, you can also customise your installation to feed all of these services from a single Raspberry Pi.

We're going to use Raspberry Pi Imager ([magpi.cc/imager](http://magpi.cc/imager)) to install the operating system image onto our microSD card. Raspberry Pi Imager is available for free for Windows, macOS, Ubuntu for x86, and Raspberry Pi OS. Download it to your usual computer and install it.

Connect your microSD card to your usual computer, using an SD card adapter if you need one. We recommend a minimum storage size of 16GB. Open Raspberry Pi Imager, click CHOOSE OS, and select 'Use custom' at the bottom of the list.

Navigate to the .img file you downloaded earlier and select it. Click CHOOSE STORAGE and select your microSD card. If you're familiar with Raspberry Pi Imager, you might expect the next step to consist of setting up the hostname, username, password, and Wi-Fi credentials using the Raspberry Pi Imager advanced menu. However, since we are using a custom operating system, we can't do this setup in this way.

Select WRITE to start the process of writing the operating system to the SD card. This may take a few minutes to complete.

## 04 Provide Wi-Fi credentials

Now that the operating system is installed on the SD card, we're nearly ready to proceed with our headless setup. However, before we begin, we will need to provide our Raspberry Pi with the Wi-Fi credentials to connect to our network. To do this, we need to alter a small file on the SD card. In order to access the contents of your SD card after the image has been transferred to the card, you will need to remove it from the computer and then reinsert it. Next, navigate to the boot drive to see its contents. Find the file named `wpa_supplicant.conf` and open it with your preferred text editor. Enter your Wi-Fi network name in the 'ssid' field and the network password in 'psk' within the quotes. Then save your changes to the file and safely eject the SD card.

## 05 Connect via SSH

Insert your microSD card into your Raspberry Pi and connect it to power. Your Raspberry Pi will now boot for the first time and will connect to your Wi-Fi network automatically, as we have already given it all the credentials it needs.

SSH, or Secure Shell, is a network communication protocol that enables two computers to communicate. Open a terminal session on your usual computer and run the following to access your Raspberry Pi computer via SSH:

### You'll Need

- ▶ Raspberry Pi 3 Model A+ [magpi.cc/3a+](http://magpi.cc/3a+)
- ▶ Micro USB power supply [magpi.cc/usbpower](http://magpi.cc/usbpower)
- ▶ microSD card (you may also need an SD card adapter, for setup)
- ▶ USB ADS-B receiver dongle (we used the NESDR Mini (TV28T v2) USB RTL-SDR, DVB-T & ADS-B Receiver Set) [magpi.cc/nesdrmini](http://magpi.cc/nesdrmini)
- ▶ Raspberry Pi 3 Model A+ case (optional but recommended) [magpi.cc/a+case](http://magpi.cc/a+case)



► **Figure 1**  
Flightradar24 enables you to see all planes with transponders operating around the world

```
ssh pi@raspberrypi.local
```

The first time you do this, you will be asked to confirm the connection. Type 'Yes' and press **ENTER** to continue. Enter the default password, 'raspberrypi', when prompted.

You'll get a warning about a security risk. Now is a good time to change your default password by typing the following:

```
passwd
```

You will be asked for the current password, and then given the opportunity to choose your own. Type it twice correctly to confirm the change.

An optional step here is to change the hostname of your Raspberry Pi. This is useful because, as it stands, your hostname is the default, 'raspberrypi'. If you add other Raspberry Pi computers to your network using this same default hostname, a conflict may arise.

## 06 Change the hostname

Change the hostname to something memorable by typing the following:

```
sudo raspi-config
```

This will take you to the Raspberry Pi Software Configuration tool.

Select '1 System Options' and then 'S4 Hostname'. This will take you to a screen detailing what characters and conditions are allowed when assigning a new hostname. Replace the existing

name 'raspberrypi' with one of your choice. For this tutorial, we chose 'Pi24':

Click OK and confirm the reboot for the change to take effect. When your Raspberry Pi has had time to reboot, SSH back into it, this time using your new hostname:

```
ssh pi@Pi24.local
```

## 07 Update everything

It's best practice to run an update task for a fresh installation of an operating system, and it's something that you should do regularly. You want to ensure the device is running with the very latest versions of all programs and security. Run the following two commands, typing 'y' and hitting **ENTER** when prompted to continue:

```
sudo apt update
sudo apt full-upgrade
```

Reboot your device to allow any changes to take effect:

```
sudo reboot
```

## 08 Setting up Flightradar24

The first step is to create an account with Flightradar24 using your email address and a password of your choice.

If you haven't already done so, you should connect your USB ADS-B receiver dongle to a USB



port on your Raspberry Pi, while the device is powered off. The antenna should also be connected by plugging it into the side of the dongle. You will feel a slight reassuring click when you attach it correctly.

## 09 Power up Raspberry Pi

Power up your Raspberry Pi once more.

Now you are logged in to Flightradar24 and your Raspberry Pi is powered on with the USB ADS-B receiver attached, it's time to carry out the final steps in setting up your new aircraft tracking station. SSH back into your Raspberry Pi and run the following command:

```
sudo bash -c "$(wget -O - https://repo-feed.flightradar24.com/install_fr24_rpi.sh)"
```

## 10 Welcome screen

After a brief period of setup, a welcome screen and some instructions will appear, followed by the first in a series of configuration steps.

In order to continue, we need three pieces of information that will uniquely specify the location of our equipment: we need co-ordinates of latitude and longitude, as well as altitude above sea level in feet. Fortunately, there are a number of websites that can provide us with this information.

## 11 LatLong

You can obtain your lat and long co-ordinates from [LatLong.net](https://www.latlong.net), either by searching for a place name or by navigating your way around the interactive map. Note down your co-ordinates to four decimal places (for example, 52.2048, 0.1304 is close enough to get you to a cracking pub in Cambridge; you don't need the extra decimal places that the website provides unless you need help to navigate between the bar and the snug, in which case it's probably time to ask your friends to take you home).

## 12 Get your altitude

You can obtain your altitude from [whataaltitude.com](https://whataaltitude.com). If you're using this site for the first time, you might be prompted to enable

location services for your browser to access your geographical position.

Note down your altitude in feet and return to your SSH connection to continue the setup process, completing Flightradar24's Step 1.1 by entering the email address that you used to register your Flightradar24 account.

We can leave Step 1.2 blank, as we have not used the service before, and move on.

## 13 MLAT calculations

MLAT, or multilateration, refers to the process of determining an aircraft's position and heading by analysing the time difference between the arrival of radio signals from the aircraft. Since ADS-B transponders are not fitted on all aircraft, particularly older planes, Flightradar24 is able to calculate aircraft positions using data from three or more other community receivers. For this tutorial we will participate, so we will answer 'yes' to proceed.

## 14 Confirm your settings

After entering the location details you noted earlier, you will be presented with the details of the nearest airport to you, followed by a final request to confirm your settings (we've redacted our coordinates in the example above, but of course you will enter your latitude and longitude to four decimal places). Enter 'yes' to continue.

## 15 Confirm hardware

Next, you need to confirm what type of receiver hardware you are using. In this tutorial, we need to select '1 - DVBT Stick (USB)'.

The remaining setup steps relate to more advanced functionality, so we'll skip over them

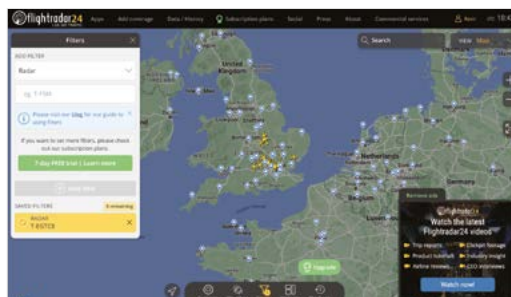

## Top Tip

### Antenna position

Try placing your antenna outside, or in an elevated position, to see how many more aircraft you can pick up.

Clicking on individual planes reveals more information including its origin, destination, type of aircraft, altitude, and more



▲ Babbage holds the completed Raspberry Pi board and dongle setup. The antenna is used to detect transponder signals

in order to get up and running with a basic setup. In Step 4.3, you can provide additional `dump1090` arguments describing how the data received by your device is processed. This should be left empty. For Steps 5.1 and 5.2, which relate to exporting data from the device to another device or program, we will answer no. Finally, Flightradar24's Step 6 allows the creation of log files, which we will disable by entering '0'.

That's the setup complete! Be sure to make a note of your sharing key and radar ID, although this information will automatically be sent to your email address for reference. If you decide to come back and explore some of the features more deeply, then you can always re-run the setup script and change your settings. But before you do so, make sure to stop the service, as instructed at the beginning of the FR24 Decoder/Feeder signup wizard.

## Top Tip

### FlightAware

In this tutorial we have used Flightradar24, but alternatives like FlightAware include multiple installation options including Raspberry Pi.

[magpi.cc/piaware](http://magpi.cc/piaware)

[magpi.cc/adsbexchange](http://magpi.cc/adsbexchange)

## 16 Viewing aircraft tracking data

Some of the magic of this project is now happening behind the scenes: your receiver is now active and sending data along with thousands of others. For now, just make sure your antenna is near a window with a view of the sky. We'll touch on antenna placement a little later in this tutorial.

The Flightradar24 operating system image for Raspberry Pi has a very convenient built-in web server; that is to say, it will host a small web page on your local network for you to see all the information your flight tracker is collecting. To access it, open a web browser on your usual computer and type the following into the address bar, replacing 'pi24' with the hostname you chose earlier: <http://pi24.local/dump1090/gmap.html>.

Press **ENTER** and you will be presented with a live view of the data being collected. Explore the

page by clicking on individual aircraft for more information about each one.

## 17 Check the community

So, that's what your device is currently doing. Now let's dive into the community to which we've begun contributing by visiting the [flightradar.com](http://flightradar.com) home page, making sure you are still logged into your account. This will now show you information from all of the receivers and different data streams in your area.

There's a lot to take in here, so we are going to simplify things and display only the aircraft that your device is currently picking up. To do this, click on the Filters icon (circled in **Figure 1**) at the bottom of your screen. This will bring up a window with the option to ADD FILTER. Use the slide bar to scroll down and select Radar.

Type in the radar ID of your receiver – the one you made a note of earlier – into the box beneath the filter type.

Finally, click on the blue 'New filter' button. The page should show a lot fewer aircraft, but these aircraft will be the ones being tracked by your receiver.

Now's the time to explore. Try clicking on individual aircraft to be amazed at how much information there is, including origin and destination details, type of aircraft, route taken, altitude, and much more.

“ Your receiver is now active and sending data along with thousands of others ”

## 18 Onward and upward

This tutorial explores the basics of setting up a Raspberry Pi aircraft tracker, and the next obvious step is to think about antenna placement for better reception (see 'Antenna position' top tip). Building on this project might take you on a journey to more complex systems with better antennas, or perhaps a solar-powered receiving station. The sky's the limit! Unless of course the sky isn't your thing and you're more interested in the sea, in which case you might want to look into receivers for automatic identification system (AIS) transponders capable of listening to position, identification, and other information about ocean-going vessels. 

# HackSpace

TECHNOLOGY IN YOUR HANDS

THE **MAGAZINE**  
FOR THE **MODERN MAKER**



SUBSCRIBE AND  
**SAVE** UP TO  
**35%**  
on the cover price



ISSUE #63

# OUT NOW

[hsmag.cc](http://hsmag.cc)



# Design your first PCB

Create some Christmas decorations and learn a new skill



**Ben Everard**

[@ben\\_everard](#)

Ben's house is slowly being taken over by 3D printers. He plans to solve this by printing an extension, once he gets enough printers.



**One of the biggest challenges with learning a new skill is having a project to start with.**

Too complex a project and it can be hard to know where to start, and you can end up going round in circles and giving up before you've really started. Too simple, and it can seem like you're not really getting anything out of it.

In this article, we're going to pick our favourite 'simple but not too simple' PCB project – Christmas lights. It'll be a little PCB that holds one or more LEDs that you can solder up. If you want to, you can add a bit more sparkle by adding addressable LEDs, but the point here isn't to flex your electronics muscles, it's to get used to PCB software and the process of ordering a PCB from a manufacturer.

There are a few PCB design tools available (Electronic Design Automation, or EDAs). The open-source KiCad is popular with makers and powerful

enough for professional use. EAGLE is a commercial tool with a slightly limited free tier for makers. However, we've found that the simplest tool for getting started is EasyEDA. It's web-based, so there's no need to install anything, and hits the Goldilocks of being simple enough to be easy to understand, yet powerful enough to actually be useful. Most EDAs follow a roughly similar workflow, so if you decide to try others later, your experience with EasyEDA should make that easier.

First, you'll need to head to **EasyEDA.com** and log in, (or create a free account if you don't have one already). Click on EasyEDA Designer, then select 'STD edition' in the pop-up. This will take you into the main window.

There are two parts to creating a PCB. First, you have to design the schematic, and then you have to design the PCB to match this schematic. EasyEDA will let you just create a raw PCB without a matching schematic, but it's hard to make sure you've

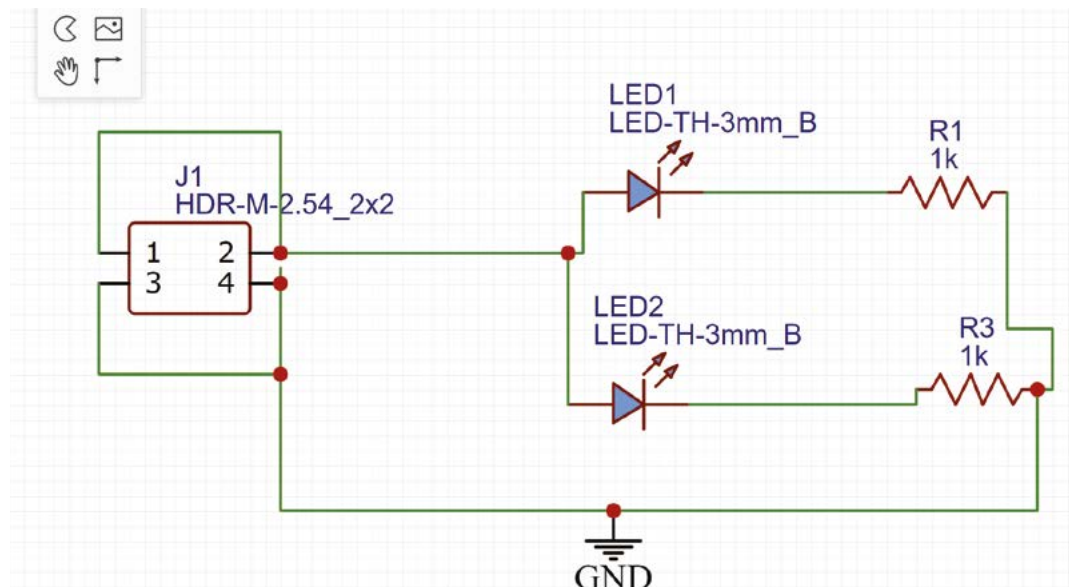

**Right** Figure 1. The simple schematic just connects up the LEDs

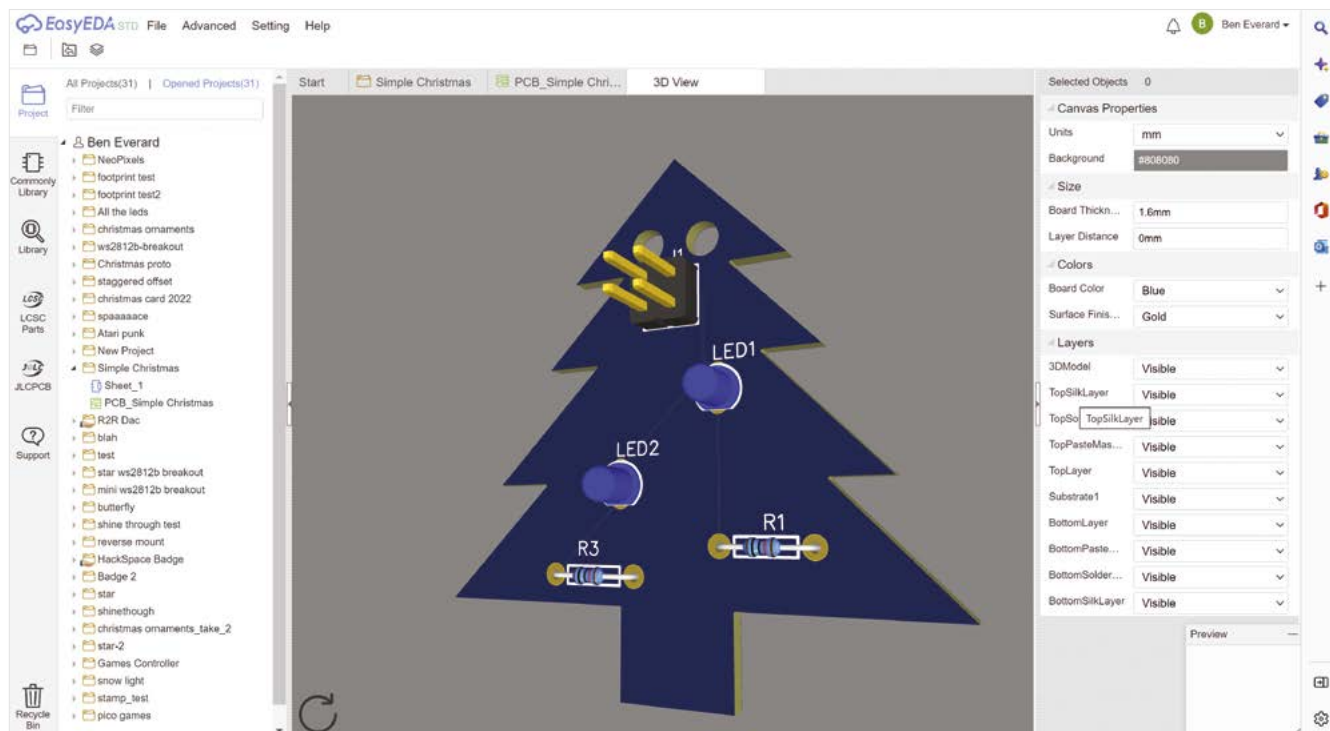

connected everything up properly, so we wouldn't recommend this method.

Go to File > New > Project and create a new project. This will create a folder in the project's list on the left-hand side, add a schematic, and drop you into the schematic's editor.

We're going to use the 'commonly used' components, so you can click the Commonly Library on the left-hand side. This gives us quick access to standard components.

All these are available from multiple manufacturers and aren't tied to a specific thing. For example, you can buy 3 mm LEDs or 0805 LEDs almost anywhere and they'll fit.

Each component needs a layout on the PCB to accommodate it. This might be pads for surface-mount parts, or holes for through-hole. It might also include PCB cut-outs to make space for the physical shape of the part. This PCB layout is known as the footprint. In EasyEDA, you select the footprint you want when you place a component. For example, we won't just add an LED, we'll add a 3 mm LED. Scroll down until you find the LED symbol, and select the footprint LED-TH-3mm\_B (the final \_B just means that it's a blue LED and this only impacts the look of the project if in the 3D viewer – you can equally select red

or green and it won't affect our PCB). Feel free to use a different LED footprint if you prefer.

Actually, add two LEDs. We also need two resistors. The resistors are a little confusing. You can select either US (zigzag) or EU (rectangle) schematic symbols, and then any footprint within each option. It doesn't really matter which symbol you select. The through-hole options are each given a number from 1.2 to 0.3 – this is the size (in inches) between

the two holes. Most 0.125-watt resistors will fit into the 0.3-inch footprint, but it can be a bit of a squeeze with some 0.25-watt resistors. Depending on what you have to hand, you'll probably want one

of those two (bear in mind that anything that fits in a 0.3-inch footprint will also fit in a 0.5-inch footprint, but the reverse isn't true).

Obviously, you can put any value of resistor into the same footprint, but setting the correct value means that it can appear on the PCB and then make the PCB easier to assemble. You can set the value by selecting the resistor and changing the value in the Name box.

The final piece of the puzzle is a way of attaching our power source. We'll add a header to solder in power leads. How you get the power is up to you. →

**You can set the value by selecting the resistor and changing the value in the Name box**

**Above** EasyEDA's 3D function lets you see your designs as they will finally look



**HackSpace**

This tutorial is from HackSpace magazine. Each issue includes a huge variety of maker projects inside and outside of the sphere of Raspberry Pi, and also has amazing tutorials. Find out more at [hsmag.cc](http://hsmag.cc).

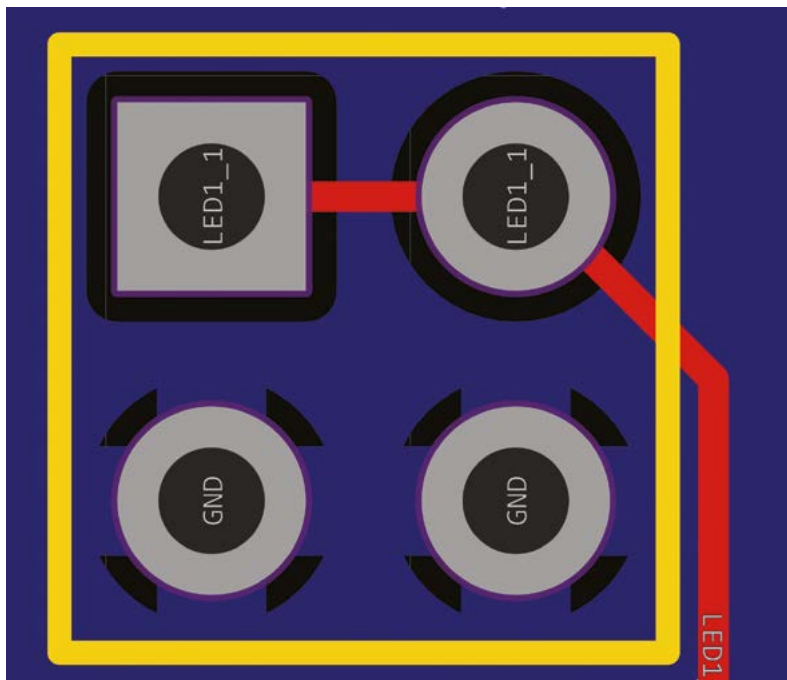

**Above** ♦  
The bottom pads join to the copper fill, while the top pads are separate

It could be from a bench power supply, or any other source of power approximately 3 to 5V.

In the connectors section, you'll see a range of different options with different numbers of pins. HDR stands for header, and that's the type we want. Not because we'll actually be adding the headers, but because they give us connections we can solder into. There are socket (F) and pin (M) versions of each, but it doesn't matter which one we want.

We want two connections – one for power and one for ground. However, it can be good to chain these PCBs together like fairy lights, and this is easier if there are two of each, so the HDR-M-2.54\_2x2 footprint is a good choice. 2.54 refers to the pin spacing in millimetres, 2.54 mm being 0.1 inches.

**Below** ♦  
Most PCB manufacturers let you preview the PCB to check it's correct

No, we don't know why resistors are sized in inches and headers in millimetres.

Those are all the parts we need, now it's time to connect them together. There should be a box labelled 'wiring tools' that you can use to select how you want to join it all together. We're going to use the simplest option and use wires. When your mouse is over a component's connection point, you should see a black circle appear. Make sure that you see that when you start connecting everything up. You can also join wires to wires, and if you do so, you'll see a red dot to indicate that the wires are all joined.

The only thing we've not added so far is the net flag. Again, you can select this from the wiring toolbox and add it in the place shown in **Figure 1**.

The connections on a PCB are known as nets. Sometimes a net will just join one component to another – as we see with the LEDs and resistors – but sometimes they're more complex. In our case, there's a single net that joins the output connections from both resistors to the header pins, and this is what we've added the ground flag to. The reason for this will become clear when we design the PCB.

That's our schematic created. Now you can save the file, and we'll start making our PCB.

### PUTTING THINGS INTO PLACE

Go to Design > Convert Schematic to PCB. There'll be a pop-up asking if you want to check nets. This just basically looks to see that everything is connected to something. This is just a quick sense check – there are many perfectly valid schematics where not all things are connected to things, and there are plenty of ways of messing up a schematic that this won't pick up. However, it's a good sense check.

If there are any problems, it won't generate the PCB and it'll show you a list with yellow warning triangles on the unconnected nets. Click on them for more info.

Once you've sorted this out, you can click on Design > Convert Schematic to PCB again and generate your PCB.

You'll get a pop-up suggesting making a board outline for the PCB. Usually, this is pretty useful and it'll take a guess at the right size. However, we're going to create ours manually a bit later, so click on Cancel.

If it does create a board outline (a rectangle in purple) anyway, highlight it and then press **DELETE** to remove it.

Next, click on the background and this will let you set the canvas properties. You can set the units to either thousandths of an inch (mil) or millimetres (mm).

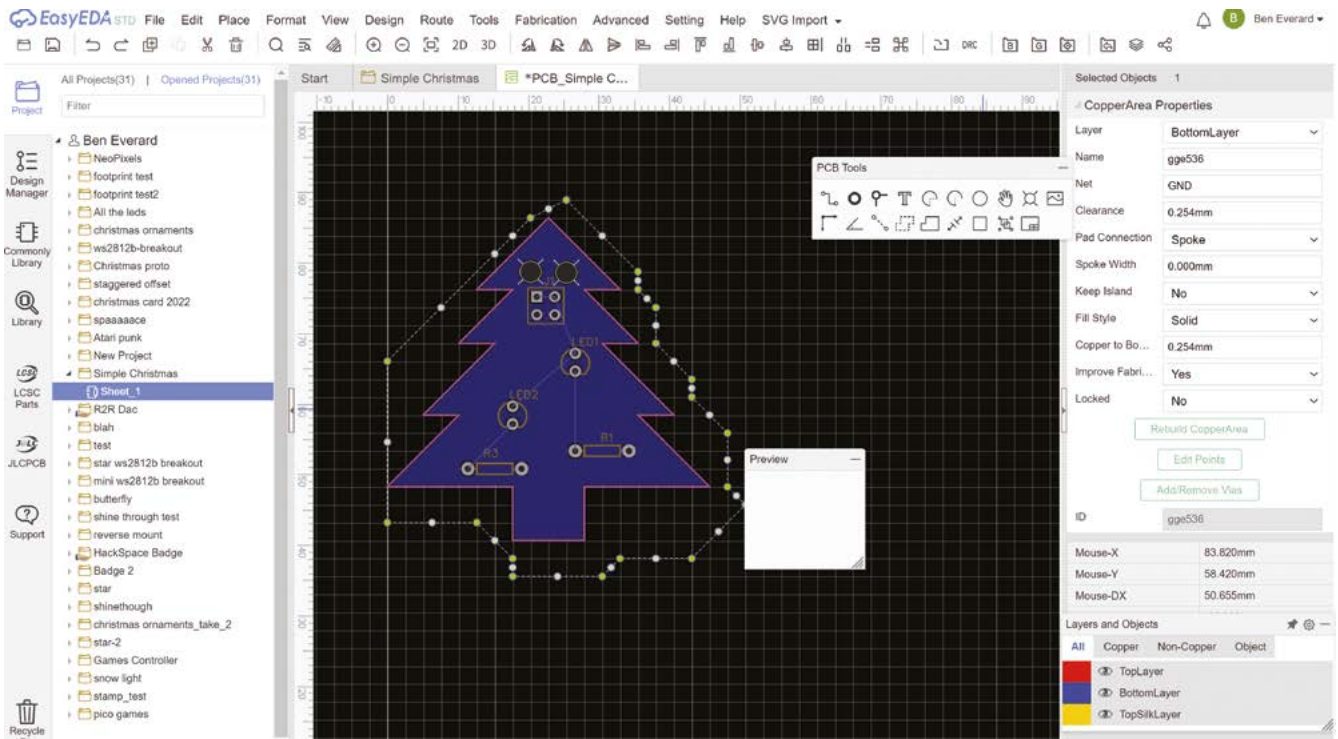

Pick the one that works for you. You can also set the snap size. When doing larger placements, we often use a snap size of 2.54 mm (100mil). This lines up with the default grid squares and is the same as the pin spacing on many PCBs. For finer things, you might have to set it smaller.

Now, draw the outline of your PCB. In the Layers and Objects box, make sure the pencil is on the board outline layer, then use the Track tool to draw the shape of your PCB. We've opted for little Christmas trees, but you can do whatever shape you want. If you want to get really artistic, you can import images

**Above** ♦  
The copper should include the whole of the PCB

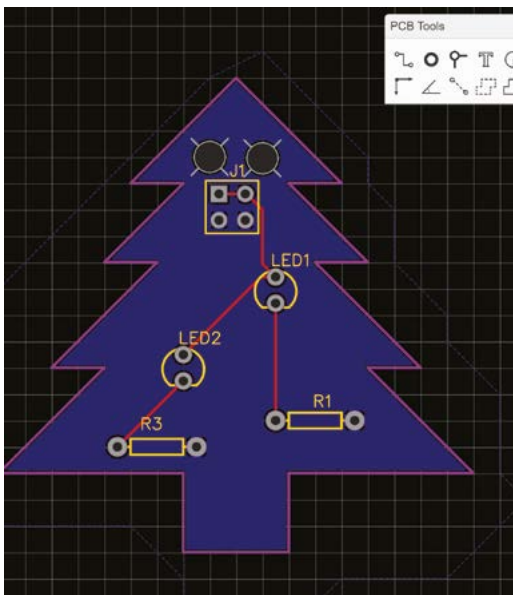

**" We've opted for little Christmas trees, but you can do whatever shape you want "**

– there is the ability to do this built into EasyEDA, but it doesn't work very well. The SVG Import Extension ([github.com/xsrf/easyeda-svg-import](https://github.com/xsrf/easyeda-svg-import)) is a much better option.

Other than the components that should have been pulled in from the schematic, the other thing we want on the PCB are two 3mm holes near the header pins. These are to let us use a cable tie to attach the power cables to the board – this makes the power cables much more secure. Use the Hole tool to place two holes, then press **ESC** to revert to the Selector tool, and then select each hole and adjust the diameter to 3mm (or whatever size cable tie you have to hand).

Now, place your components wherever you want them. For a simple PCB like this, you can probably put them anywhere, but for more complex PCBs, you →

**Above** ♦  
You should be able to route the whole PCB without needing to cross wires

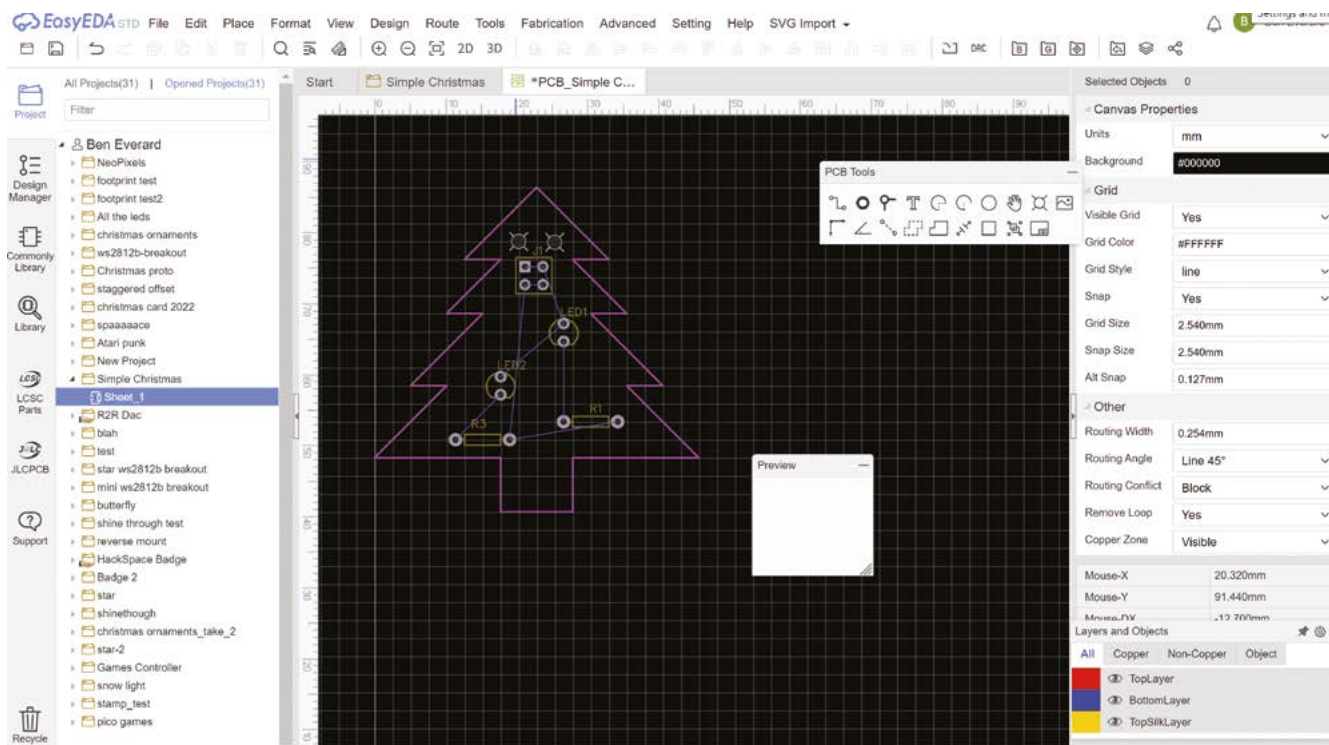

**Above** ♦  
The different colours represent different aspects of the PCB design

might have to think a little about how you can route all the connections.

We're almost ready to start connecting up our PCB but, before we do, we're going to convert the entire bottom layer of our PCB to a ground plane. This is a big copper area that's all connected to ground. We do this for a few reasons – but the main one for PCBs is a little complex. If you have an electrical signal that changes very rapidly, it can emit electrical interference that can affect bits of the PCB that aren't connected to it. Adding a ground plane helps mitigate this. That's a very simplistic explanation of a complex phenomenon that we're not going to delve into further, but ground planes are good and while not really necessary on this PCB, they tidy up the traces and are a good habit to get into.

We'll add ours to the bottom layer, so select the bottom layer in the Layers and Objects box, then select the Copper Area tool (it looks like two dashed rectangles). Draw around the edge of the PCB. It doesn't have to be precise, just make sure your entire PCB is inside the copper area. Once it's done, it'll calculate the copper area and you should see

**Ground planes are good and while not really necessary on this PCB, they tidy up the traces**

your PCB fill with blue. If you look very closely, you'll notice that some of the pads are connected to the blue copper area while some aren't. You should also note that some of the light blue 'rats nest' lines that indicate our connections have disappeared because those connections are now 'routed' by the copper fill.

This copper area won't automatically recalculate if you move components, or do anything that will affect it. If you need to at any point, select the copper area and click 'rebuild Copper Area' in the right-hand panel.

The final thing to do is route the rest of our traces. First, make sure that the top layer is selected, then use the Tracks tool to join up all the necessary pads (that are linked by pale blue lines). You'll probably find that you can do all this in just the top layer, but if you've got a bit complex, you might find that you can't do this. If so, you need to switch to the bottom layer and add some track there. All our components are through-hole, so you can connect to them on either layer.

You can also link top and bottom layers using a 'via'. These are holes through the PCB that you can connect to from either layer.



Once you've fully routed your design, save your work (if you haven't already), and you can have a look at a 3D render of it by pressing the 3D button.

## ORDERING YOUR PCB

Now it's time to order your PCBs. This is the part that many people find daunting, partly because there are lots of options, and partly because it involves parting with real money.

We need to generate a 'Gerber' file, this is a standard set of files in a zip archive that is supported by almost every PCB manufacturer out there. There are some slight differences in how Gerbers can be packed, but the output from EasyEDA should work with most fabricators.

Go to Fabrication > Generate Fabrication Files (Gerbers). There'll be a pop-up asking if you want to check DRC (Design Rules Check). This is a way of checking that your PCBs are actually manufacturable and don't include things like traces too close to holes. It's a good idea to check this, but bear in mind that we haven't taken the time to set the design rules that it's checking. There are plenty of options and we're just going with the defaults.

Hopefully, DRC will pass and you'll be taken on to the 'download Gerbers' page. Click on Generate Gerber and you should download a zip file.

There are hundreds of PCB manufacturers to choose from, and they vary quite a lot in price. Most will offer an online quote where you can upload your Gerbers and it'll tell you straight away what the price will be. Do bear in mind that the shipping can often cost more than the PCBs.

On the PCB order form, there will be a huge range of options and you can usually accept the defaults on all of them. The one exception is that many default to a leaded surface finish, while we'd recommend a lead-free option.

Typically, you'll have to have at least five copies of your PCB, but see what it says on your manufacturer's website.

A few options you might see on the PCB order page:

- **Material:** FR4 – this is the standard type of fibreglass PCBs are made from.
- **Thickness:** It doesn't really matter for this – about 1.6mm is normal.

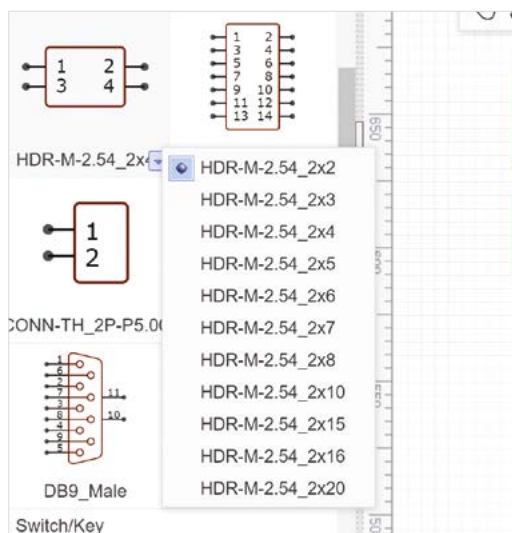

**Left**  Use the drop down arrow to select variations on components

- **Solder mask colour:** The majority of your PCB will be covered in this. Green is the most common option, but they all work the same.
- **Minimum track spacing:** This is unlikely to be a problem with a simple PCB (and DRC will complain if you've done anything strange).
- **Minimum hole size:** This is unlikely to be a problem.
- **Surface finish:** Copper corrodes very quickly, so any exposed copper is usually covered with a finish that's either silver-coloured (HASL) or gold-coloured (ENIG). HASL – which stands for Hot Air Solder Levelling – is far cheaper. We'd strongly recommend going with lead-free HASL.
- **Via process:** If you've not added any vias, this is irrelevant, but if you have, you probably want them tented (i.e. covered in solder mask).
- **Copper weight:** This is how much copper is on one square foot of PCB. 1 oz is pretty common, and perfect for our use case.

With this selected, you can place your order. Perhaps the hardest part of ordering a PCB is waiting for delivery. This can often take two or three weeks. After this, you can solder them up and see if they work. With the double-header on the top, you can daisy-chain them together to make a Christmas decoration to show off your new-found PCB design skills. 

# Make a Tide Tracker with APIs and an e-ink display



**Nik Rawlinson**

Coffee-drinking typewriter lover with a penchant for pencils and paint. Frequently found staring at the sea from the back of a camper van.

[nikrawlinson.com](http://nikrawlinson.com)

Surf's up, or is it? Save yourself a wasted trip to the beach with our handy tide tracker

**T**ides are predictable, but it's still easy to lose track of the times for high and low water. As a result, you might pull up at high tide to find the beach has disappeared... or at low tide, and found your boat grounded. Put an end to that once and for all with our handy tide tracker, which uses an API to download tidal forecasts for more than 600 monitoring stations around the UK. The results shouldn't be used for navigation or other water-borne activities, but

they may be just what you need to save yourself a wasted journey, or to keep an eye on the tide cycles however far you live from the coast.

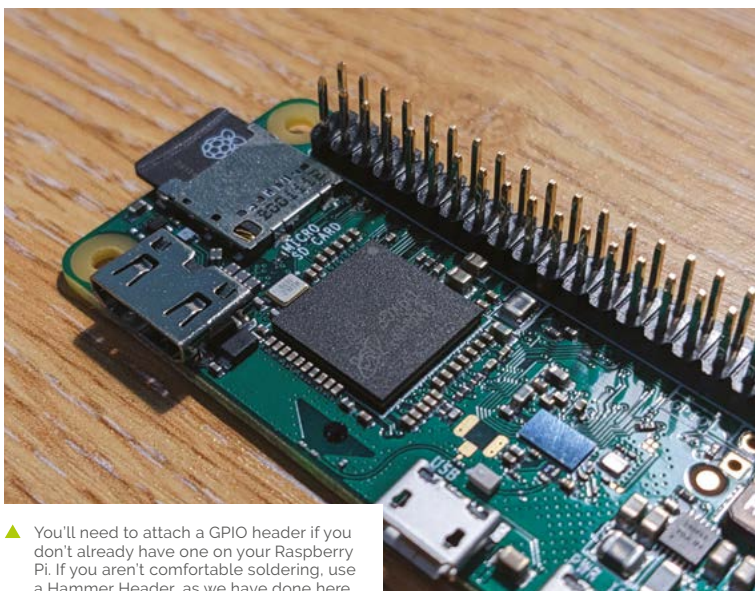

▲ You'll need to attach a GPIO header if you don't already have one on your Raspberry Pi. If you aren't comfortable soldering, use a Hammer Header, as we have done here

## 01 Attach a header

We're using a Raspberry Pi Zero 2 W for this project. If you're using the same and don't already have a GPIO header in place, you'll need to solder one using the two rows of connectors at the top edge of the board. If you're not comfortable soldering, instead use a GPIO Hammer Header, which you can knock into position using a hammer and installation jig. Once your headers are fixed, attach the e-ink display, then connect your Raspberry Pi to a USB power source and allow it to boot

## 02 Install display libraries

Whatever display you're using, you'll first have to install the libraries that Python needs when it wants to communicate with it. We're using an Inky pHAT, for which Pimoroni has published an excellent getting started guide at [magpi.cc/getstartedinkyphat](http://magpi.cc/getstartedinkyphat). Follow the instructions there for installing the necessary software, by opening a new Terminal window (click the icon on the taskbar) and typing:



### You'll Need

- Inky pHAT  
[magpi.cc/inkyphat](https://magpi.cc/inkyphat)
- GPIO headers  
[magpi.cc/colourheader](https://magpi.cc/colourheader)
- (Alternatively) GPIO Hammer Header  
[magpi.cc/hammerheader](https://magpi.cc/hammerheader)

```
curl https://get.pimoroni.com/inky | bash
```

When the process has finished, reboot your Raspberry Pi.

### 03 Register for an Admiralty account

We're going to use data compiled by the UK Hydrographic Office. Although it charges for much of its data, its free Discovery tier gives access to data for 607 tidal stations around the UK. Open a browser window at [magpi.cc/uktidalapi](https://magpi.cc/uktidalapi), check the Terms of Use and, if you're happy to be bound by them, set up an account by subscribing to the service. When your account is up and running, log in, then click your name at the top right of the page, followed by Profile. Click Show on the line beside 'Primary key', and copy the subscription key this reveals into a plain text document for later use.

### 04 Find your tidal station

You now need to find the numeric identifier of the tidal station whose data you want to retrieve. While still logged in, point your browser at [magpi.cc/tidalstations](https://magpi.cc/tidalstations) and type the name of a coastal location in the box labelled 'name'. Leave everything else on the page as it is, and click the Send button. Assuming you entered a valid location, the query's output will appear in the 'Response content' box. Copy the variable beside Id in the Properties section. We searched for Broadstairs, for which the 'Id' variable reads

0102A. You'll need to include the station identifier in your query.

### 05 Understand how tides work

Our gauge will illustrate the tide's rise and fall at any station, always showing how far it is from its maximum or minimum height. We don't need live height data to produce the graph if we apply the rule of twelfths, which governs how

“ Our gauge will illustrate the tide's rise and fall at any station ”

tides move and gives a good approximation of the current position based on the interval between the most recent and next low or high tide. If you break down the interval into six equal periods, the tide height will change by 1/12th of its total range in the first and last periods, by 2/12th (a sixth) of its range in the second and fifth periods, and by 3/12th (a quarter) of its range in the third and fourth periods. You'll apply these ratios in the code.

### 06 Get coding

Type out or download the `tides.py` code and amend it to your requirements, changing lines 3 to 14 as appropriate if you're using a different e-ink display. Replace `<id>` on line 19 with the ID of the tidal station you're monitoring, and `<key>` with

### Top Tip

Not in the UK?

The data we're using only covers UK tidal stations, but equivalent data is routinely published by government agencies around the world.

your subscription key. Lines 23 to 33 are worth closer examination. Because the query pulls down every low or high tide event for 48 hours, you need to find when the next one is due. So, the code first cycles through each event in the returned data and converts its time stamp to its UNIX equivalent, which counts the number of seconds since 1 January 1970.

## 07 Deal with the unexpected

Notice how line 26 reads:

```
at = at[:19]
```

The variable `at` holds the time stamp associated with each high or low tide event. Usually this takes the 19-character form YYYY-MM-DDTHH:MM:SS (as you'll see, there's a T in the middle, which marks the transition from date to time). However, occasionally the time stamp returned by the query is more specific, and includes an additional half second. We need to discard this in our calculations, so line 26 trims the contents of the `at` variable to 19 characters before moving on. If there was no additional half second, this would have no effect, but also wouldn't throw up an error.

## 08 Calculate the tidal cycle

As the code continues cycling through the data, it stores the time of each tidal event until it reaches the first one that hasn't yet happened, then quits the loop. It now has two time stamps stored in variables: one for the previous event, and one for the next. Subtracting the former from the latter tells us how long, in minutes, the transition from low to high or high to low tide takes. We divide 100 by that number to work out what proportion, in percentage terms, is represented by a single minute. Then, in lines 54 to 71, we set a multiplier, based on our rule of twelfths, that will allow us to plot a fair approximation of the tide's position within its cycle on our display.

## 09 Define the bar chart

The tide's progress will be tracked using a bar chart, the length of which is calculated on lines 82 to 84. However, it wouldn't be clear from just a glance at the bar whether the tide was rising



or falling. So, it's accompanied by a line of text indicating what the next event is (high or low tide) and when it will occur. For the latter part of the text (the bit dealing with the time), we'll extract a subsection of the data held in the variable `at`. On line 86, we assign the 11th to 16th characters of `at`, which contains the two hour digits, a colon, and two minute digits, to a new variable called `event_time`.

▲ We're using an Inky pHAT display, but you can adapt the code for other screens

## 10 Refresh the display

Now that our code has constructed the display's contents in memory, we need to transfer it to the e-ink panel. This task is handled by lines 106 and 107, which send the constructed image to the screen when we run the code in step 11. If you're using a colour display, you may notice that it will take a few seconds to refresh. This is normal. However, if you want to speed it up, go back into your code and change line 9 to:

```
inky_display = InkyPHAT("black")
```

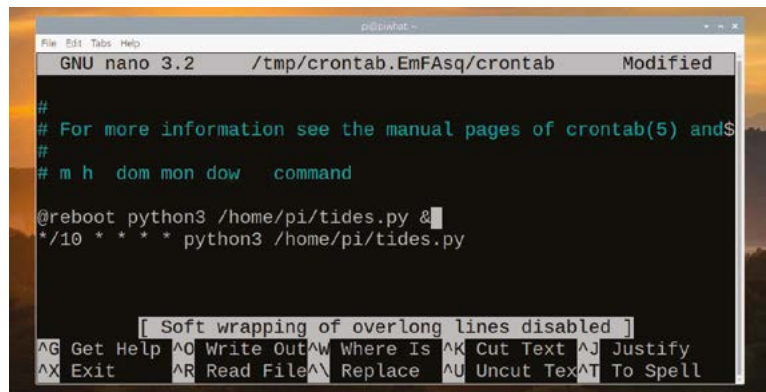

▲ Use cron to run your code periodically and keep the reading updated

# tides.py

> Language: **Python**

**DOWNLOAD  
THE FULL CODE:**



**magpi.cc/tidespy**

```

001. # import necessary libraries for data retrieval
    and drawing to Inky pHAT
002. import urllib.request, json, datetime, time
003. from PIL import Image, ImageFont, ImageDraw
004. from inky import InkyPHAT
005. from font_fredoka_one import FredokaOne
006.
007. # define Inky pHAT parameters
008. # change "red" in line below as appropriate for
    your display
009. inky_display = InkyPHAT("red")
010. inky_display.set_border(inky_display.BLACK)
011. img = Image.new("P", (inky_display.WIDTH,
    inky_display.HEIGHT))
012. draw = ImageDraw.Draw(img)
013. width = inky_display.WIDTH
014. percentwidth = 100 / width
015.
016. # draw down data from the UK Hydrographic Office
017. # replace <id> with your station id
018. # replace <key> with your subscription key
019. with urllib.request.urlopen("https://
    admiraltyapi.azure-api.net/uktidalapi/api/V1/
    Stations/<id>/TidalEvents?duration=2&key=<k
    ey>") as url:
020.     data = json.load(url)
021.     datalength = len(data)
022.     # cycle through data to find next event
023.     for x in data:
024.         event = (x['EventType'])
025.         at = (x['DateTime'])
026.         at = at[:19]
027.         when = datetime.datetime.strptime(
    at, "%Y-%m-%dT%H:%M:%S")
028.         unix = datetime.datetime.timestamp(
    when)
029.         now = time.time()
030.         if unix > now:
031.             break
032.         previous_event = event
033.         previous_at = unix
034.
035. # calculate minutes until next event
036. next = (unix - now) / 60
037.
038. # calculate minutes since previous event
039. previous = (now - previous_at) / 60
040.
041. # calculate time between events
042. total = next + previous
043.
044. # calculate what percentage is represented by
    a single minute
045. percent = 100 / total
046.
047. # multiply percentage by time since last event
    to find elapsed percentage
048. progress = percent * previous
049.
050. if event == "LowWater":
051.     progress = 100 - progress
052.
053. # calculate start point and set multiplier
054. if progress < 8.33:
055.     start = 0
056.     multiplier = 1
057. elif progress > 8.33 and progress < 25:
058.     start = 8.33
059.     multiplier = 2
060. elif progress > 25 and progress < 50:
061.     start = 25
062.     multiplier = 3
063. elif progress > 50 and progress < 75:
064.     start = 50
065.     multiplier = 3
066. elif progress > 75 and progress < 91.66:
067.     start = 75
068.     multiplier = 2
069. else:
070.     start = 91.66
071.     multiplier = 1
072.
073. #subtract completed start point from minutes
    remaining to find remainder
074. remainder = progress - start
075.
076. #calculate percent value of remaining minutes
077. remainder_percent = percent * remainder

```

DOWNLOAD  
THE FULL CODE:

 [magpi.cc/tidespy](https://magpi.cc/tidespy)

```

078. #multiply remaining minutes by
079. multiplier
080. remainder_percent = remainder_percent
    * multiplier
081.
082. calculated = remainder_percent +
    start
083. bar = calculated
084. barout = (width / 100) * calculated
085.
086. event_time = at[11:16]
087.
088. if event == "LowWater":
089.     e = "Low tide at " + event_time
090. else:
091.     e = "High tide at " + event_time
092.
093. mid = inky_display.HEIGHT / 2
094. font = ImageFont.truetype(
    FredokaOne, 20)
095. low = "Low"
096. high = "High"
097. w, h = font.getsize(high)
098. w1, h1 = font.getsize(e)
099.
100. draw.line(((0,inky_display.HEIGHT
    * .33), (inky_display.WIDTH, inky_
    display.HEIGHT * .33)), fill = 1,
    width = 1)
101. draw.line(((0,inky_display.HEIGHT
    * .66), (inky_display.WIDTH, inky_
    display.HEIGHT * .66)), fill = 1,
    width = 1)
102. draw.rectangle(((0,inky_display.
    HEIGHT * .33), (barout,inky_display.
    HEIGHT * .66)), fill = 2, width = 1)
103. draw.text((5,0), low,
    inky_display.BLACK, font)
104. draw.text((width - 5 - w, 0), high,
    inky_display.BLACK, font)
105. draw.text(((width - w1) / 2, inky_
    display.HEIGHT - h1), e,
    inky_display.BLACK, font)
106. inky_display.set_image(img)
107. inky_display.show()

```

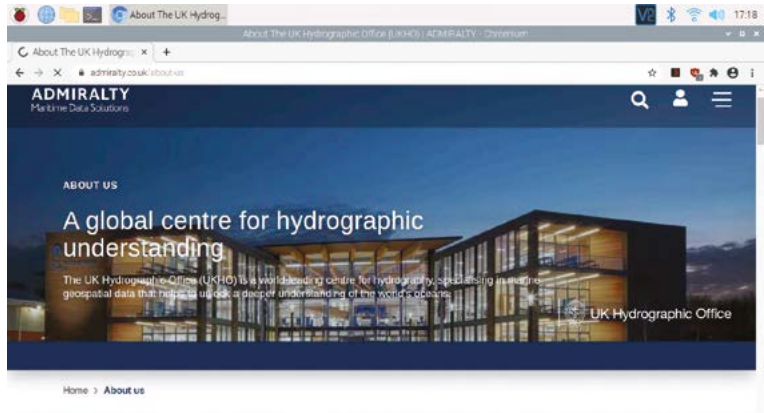

## 11 Run your code

If necessary, move the code into the root of your user folder and save it as **tides.py**. Now, open a Terminal window by clicking the icon on the taskbar. At the prompt, type:

```
python3 tides.py
```

...and press **RETURN**. The Python interpreter will run your code and, after a few seconds, you should see the display refresh to show the current tidal position, with details of the next tidal event on the line below.

## 12 Run your code automatically

Assuming your code did what you expected, you can set it to run automatically and refresh at set intervals. Type:

```
crontab -e
```

If you've never edited crontab before, you'll be asked which tool you want to use. Select 1 for Nano. When Nano opens, key down to the bottom of the file, create a new line, and type:

```
@reboot python3 /home/pi/tides.py &
*/10 * * * * python3 /home/pi/tides.py
```

The first line tells Raspberry Pi OS to run your code as soon as it starts, with the **&** at the end telling it to run the process in the background. The second line tells it to run the code every 10 minutes thereafter. Press **CTRL+X** to quit Nano, confirm that you want to save your edit, then reboot your Raspberry Pi. 

▲ The data we're using is compiled by the UK Hydrographic Office

## Top Tip

### Next issue

In the next issue, we'll rework this project using MicroPython, for use with the colourful Galactic Unicorn with built-in Raspberry Pi Pico W.

# RETRO GAMING

WITH

# RASPBERRY PI

## 2<sup>ND</sup> EDITION

***Retro Gaming with Raspberry Pi*** shows you how to set up a Raspberry Pi to play classic games. Build your own games console or full-size arcade cabinet, install emulation software and download classic arcade games with our step-by-step guides. Want to make games? Learn how to code your own with Python and Pygame Zero.

- *Set up Raspberry Pi for retro gaming*
- *Emulate classic computers and consoles*
- *Learn to code your own retro-style games*
- *Build a console, handheld, and full-size arcade machine*

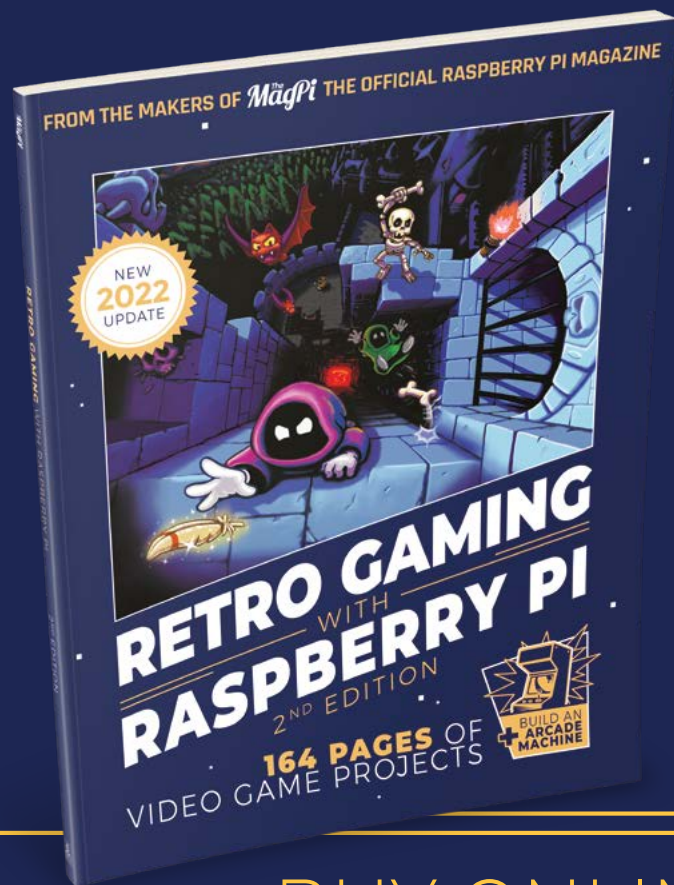

BUY ONLINE:  
[magpi.cc/store](https://magpi.cc/store)

# CREATE SMART LIGHTS

Use Raspberry Pi and Raspberry Pi Pico to make your indoor and outdoor lights a little more clever and automated.  
Illuminated by **Rob Zwetsloot**

---

**I**n many ways, we do live in a sci-fi future. One of those ways is home automation – with so much controllable from an Alexa or Google Nest thanks to smart plugs, Wi-Fi-controlled thermostats, and light bulbs.

Thanks to Raspberry Pi and Raspberry Pi Pico, you can further, heavily customise your home automation system, and the perfect place to start is with your lighting setup. From colourful LED displays to simply turning your sitting room lights on, you can do it all with Raspberry Pi. Let there be light.

---



# LOW EFFORT AUTOMATION

Simple smart lights anyone can make

## MOTION-SENSING LIGHTS

A PIR sensor is a cheap component that's able to detect motion by sensing the changing infrared radiation given off by people moving in its view. You can use them for floodlights, or to save on energy bills by having lights automatically turn off if no one is present. Find out more at: [magpi.cc/smartpir](http://magpi.cc/smartpir)

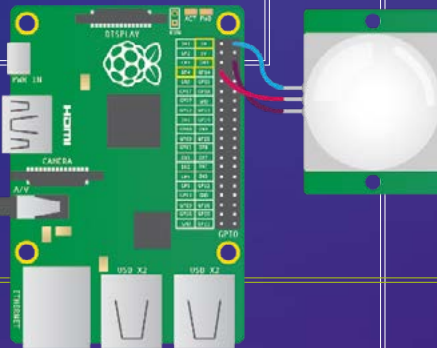

## NIGHT LIGHT

A light-dependent resistor, or LDR, changes resistance depending on the amount of light. Changes in resistance mean a change in current due to Ohm's law ( $\text{Voltage} = \text{Current} \times \text{Resistance}$ ), which, with proper calibration, can be used to detect when it's dark to turn on a light. You'll need to use a capacitor or extra circuits with a Raspberry Pi to properly detect it, though, as it requires some analogue sensing. Read more about it at: [magpi.cc/smartldr](http://magpi.cc/smartldr)

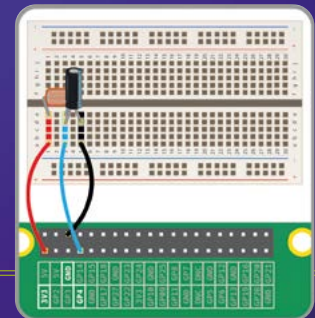

## USING NEOPIXELS

One of the more popular ways to use programmable LEDs is NeoPixel strips. Using them on Raspberry Pi and Pico is similar. However, we recommend using an external power supply for the positive rail on Raspberry Pi, while with Pico you can use the 5V GPIO pin with a resistor between them. Check out our Poltergust G-00 guide for more info: [magpi.cc/122](http://magpi.cc/122).



# PICO-POWERED SMART LIGHTS

Use LEDs with a Raspberry Pi Pico to make your home a little more colourful

**I**t's never been easier to line your home with hundreds of LEDs to create cool and fun lighting for displays, setting a mood, or even just as a nice thing to look at.

With a little bit of extra code and thought, you can make your LEDs do a lot more.

## LED ideas

NeoPixel LEDs come in many forms. Most commonly, you'll find them as strips of flexible LEDs connected to each other as a reel. With these you can cut off as many as you want/need and connect one end to a Pico. They also come in rings, straight and curved PCBs, and even as single programmable LEDs.

For most displays, a reel of LEDs is probably going to be what you need. They can be quite flat and discreet, and attaching them with glue under a shelf, out of view, works well. You can always adjust the brightness with code after all. Drilling small holes for wires to run through can easily be hidden when they're under a shelf as well.

Make sure to measure your space before getting your reel, and make sure to get more than that to account for any issues. Don't worry too much about how many LEDs there are per metre, as they can be very bright.



## Pico programming

We like using CircuitPython on Pico for controlling NeoPixels. It has a lot of really powerful lighting functions and patterns, and can be used in various ways as well. You can also control multiple different LED strips at once very easily.

For true smart lighting, connecting your Pico to a network is essential. CircuitPython has recently been updated to allow internet connections on a Pico W. Very simply, you need to create a settings file with the correct Wi-Fi details, and then make sure to tell your main code file to connect to the internet.

Full details can be found on the Adafruit website here: [magpi.cc/circuitw](https://magpi.cc/circuitw).

## IN SHORT

- Use a reel of NeoPixels
- Get more LEDs than you need just in case
- Affix them under a shelf or hidden from view

## WEB INTERFACE

### RASPBERRY PI BERET

Sean O'Steen made this special beret for a couple of purposes: the first was to have something fun and recognisable while attending the busy SiliCon event in San Jose, and the other was to learn about threading in Pico programs.

This very special project has a web server running that allows you to update the LEDs on the fly. It's a perfect use case for smart lights.

[magpi.cc/picoberet](http://magpi.cc/picoberet)

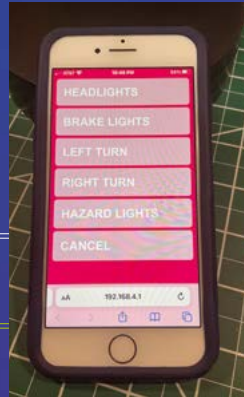

▲ The interface is simple and easy to customise for your uses

▶ The beret has turn signals and brake warnings so people behind Sean would know where he was going

## PATTERNS

CircuitPython has various light patterns built into it. For displays, you could set a themed colour cycle, or just have the lights slowly pulsate. All the different animation types can be found here: [magpi.cc/ledani](http://magpi.cc/ledani).

## TIMER

Turning lights on and off at certain times is a very basic way of making smart lights. With Pico W, you can poll network time ([magpi.cc/circuitntp](http://magpi.cc/circuitntp)) or an online clock to get the current time, allowing you to set on and off periods.

## VOICE CONTROL

### VOICE-ACTIVATED LED STRIP

Voice control is a must to make lights truly smart. Even on Pico W, you can have voice control using Edge Impulse. It requires a few extra parts, but this great tutorial by Alex Wulff covers everything you need to know about getting Pico to recognise voice commands:

[magpi.cc/voicepico](http://magpi.cc/voicepico)



▶ A microphone is the main extra component you'll need for this

## SEASONAL

Taking concepts from timed events and even patterns, you can have automated red and green Christmas lights or spooky purples and oranges for Halloween. Programming these separately is easy to do by looking up RGB colour codes.

# RASPBERRY PI-POWERED

# S M A R T L I G H T S

Full home automation with smart lights and Raspberry Pi

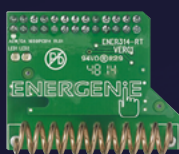

▶ Energenie plugs can be remote controlled as standard but you can unlock many automation features with the add-on board

## One of the most popular hobby uses for Raspberry Pi is for home automation.

You can get many add-ons, HATs, and connected devices that talk to it, and the internet is full of tutorials and guides. We've even done a few big articles about it ourselves. Here are some tips for controlling your lights.

## Energenie automated plug sockets

A safe way to control lights and lamps, Energenie is a smart plug socket that provides an add-on board for Raspberry Pi that allows it to communicate with the plug socket wirelessly. You can get info on the plugs and add-ons at [energenie4u.co.uk](http://energenie4u.co.uk), and a simple Python library is all you need to connect to it.

Long-time friend of the magazine Stewart Watkiss also has a good guide on how to control the sockets using a web interface, which you can find here: [magpi.cc/webenergenie](http://magpi.cc/webenergenie).

## Home automation relays

A more advanced way of controlling different electronics in your house is with programmable relays. There are many HATs and products that talk to Raspberry Pi that you can use to control relays. However, do exercise caution while using them as they can involve higher voltages, so are best used by people experienced with electronics.

We recently reviewed RelayFi, which is a more standalone board. However, something like Pimoroni's Automation HAT is a good way to connect to devices via relays, and includes some great

Pimoroni software to boot: [magpi.cc/automationhat](http://magpi.cc/automationhat).

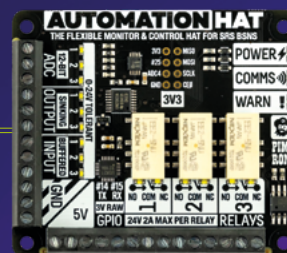

▶ Pimoroni's Automation HAT can connect to a lot of devices for great home control

# PIHUE

## WIRELESS LIGHTS

Control your light bulbs directly  
from your Raspberry Pi

Find the full  
instructions at  
[magpi.cc/pihue](http://magpi.cc/pihue)

### 01 Hue bulbs and bridge

For this you'll need Philips Hue lights, Wi-Fi controllable bulbs, and a Hue Bridge to control them from. You'll need to learn the IP address for the Bridge when it is connected to the network, which can be done with a network sniffer or in your router's admin details.



### 02 PiHue code

Tim Richardson's PiHue code works by controlling an entire room of lights, or individual lights. You'll need to add the IP of the Hue Bridge into the 'bridgeip' field in the code. From here, you can also change the list of colours for the light to take, as well as alert patterns and other functionality.



## VOICE CONTROL

There are plenty of voice assistant programs you can use with Raspberry Pi – for a start, it's possible to use Google Voice and Alexa, which already have powerful AI control functions. This video by Relax Tech is a good look at one way to make use of voice control for lights: [magpi.cc/voicelights](http://magpi.cc/voicelights).

### 03 Touch control

PiHue is set up to work with a Pimoroni Touch pHAT, with different functions respectively. For the base code, this has the lights turn on or off, flash a specific colour, or has them at maximum brightness. You can change this, or even get rid of the Touch pHAT entirely and replace it with a web interface. [M](#)



# Galactic Unicorn (Pico W Aboard)

## SPECS

### DISPLAY:

53×11 matrix of RGB LEDs (583 in total)

### FEATURES:

Pico W on board, 10 × push-buttons, mono I2S amp and 1W speaker, 2 × Qwiic/STEMMA ports, battery connector, 2 × metal legs

### DIMENSIONS:

331 × 79 mm

► Pimoroni ► [magpi.cc/galactic](https://magpi.cc/galactic) ► £50 / \$50

Shining like a galaxy of stars, this Pico W-powered RGB LED display will light up your projects. **By Phil King**

**W**ith no fewer than 583 RGB LEDs in a 53×11 grid, this matrix display has an unusually elongated shape. However, the Galactic Unicorn is packed with features and is easy to program in MicroPython (or C++ if you prefer).

As its full name suggests, it's powered by a Pico W pre-soldered to the rear of the display. You get all the power of Pico W's RP2040 chip to drive the LEDs, along with Wi-Fi connectivity.

When you first power on the Galactic Unicorn, via the supplied short micro-USB cable, it immediately springs into life with Pimoroni's MicroPython firmware and code examples pre-installed, so there's no need to flash it. Text on the display invites you to press the A, B, C, or D button to launch a different graphical demo.

Whichever button you select, you're sure to be impressed. There's a cool (or

rather warm) burning flames effect, an eighties supercomputer (random pixels), a cycling rainbow, and a nostalgia computer prompt. What you notice straight away is how these pixels are large and bright (dazzling at the maximum level) – and there's no sign of flicker, even if you film the display running. The Pico W RP2040's PIO state machines are used to drive the LEDs at around 300 fps at 14-bit resolution, while gamma correction is applied to image data.

## Button controls

Those four tiny tactile buttons are situated on the rear, along with five others on the opposite side to sleep the display, adjust the brightness, and alter the volume from the mini 1W speaker on the rear. They're also labelled on the front of the board for easy reference so you can reach behind to press them. In addition, there's a handy reset button on the rear to reboot the device.

Also on the back, along with some nifty silkscreen artwork, you'll find an optional battery connector (for up to 5.5V) and a couple



▲ Pre-soldered to the rear, a Pico W drives the LEDs at a super high frame rate



◀ The clock code example fetches the accurate time via Wi-Fi from an NTP server

of Qwiic/STEMMA ports (JST-SH) for connecting breakouts such as sensors. The Galactic Unicorn even has one sensor built-in: a phototransistor at the right-hand edge of the front panel to detect light levels – which could be useful for adjusting the display brightness automatically.

While the LEDs have some built-in diffusion, you may want to add your own diffuser panel, in which case the mounting holes should come in useful. Example DXF files are supplied on the

“ You get all the power of Pico W's RP2040 chip to drive the LEDs ”

product page. To stand the board vertically, at a slight angle, two metal legs are supplied and screw into any of four slightly larger holes in the board edge.

### Pixel programming

Programming the Galactic Unicorn should prove relatively easy in MicroPython. Several further code examples are supplied on the GitHub repo. These include a fairly convincing, procedurally generated lava lamp and an easily adaptable scrolling text demo. Graphics and text are generated using the PicoGraphics library – used for several of Pimoroni's displays, it offers rich functionality including shapes, sprites, and a selection of fonts. Other functions are explained in the Galactic Unicorn reference guide: [magpi.cc/galacticref](https://magpi.cc/galacticref).

There are a few examples that make use of Pico W's wireless connectivity too. Just pop your Wi-Fi network details into the **WIFI\_CONFIG.py** file to get connected. A digital clock demo fetches the live time from an NTP server; a Cheerlights history slowly builds up coloured pixels, one every five minutes; while a Galactic paint program enables you to draw on the display in real-time from another device via a web server hosted by Pico W – very cool indeed!

With a little creativity, there's the potential to use the Galactic Unicorn for a wide range of projects, including wireless ones such as a live weather dashboard or scrolling RSS feed. 🍷

## Verdict

Its elongated shape may not suit all projects, but this is one dazzling display that makes uses of Pico W's power to create impressive animated effects at a super high frame rate.

9/10

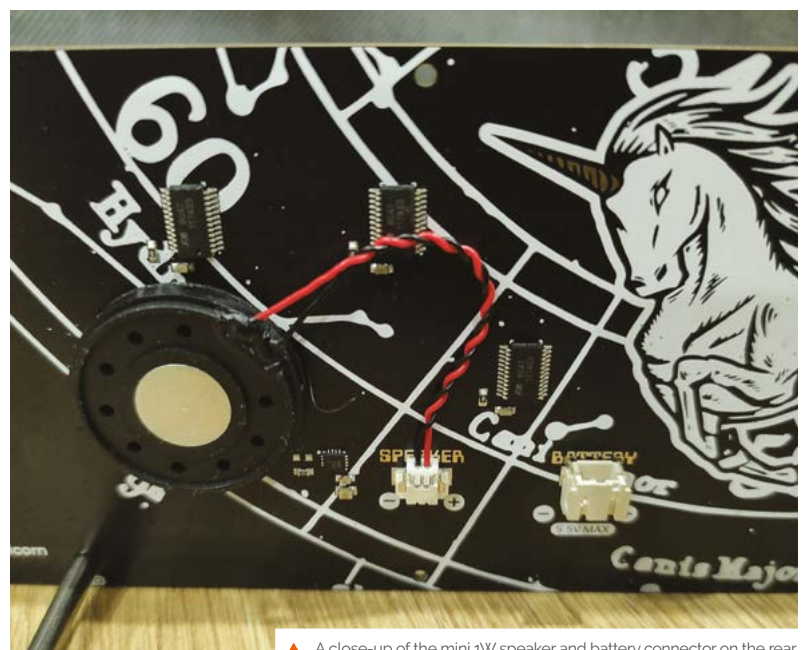

▲ A close-up of the mini 1W speaker and battery connector on the rear

# 10 Amazing: Art programs

Get creative on Raspberry Pi with these excellent apps

**R**aspberry Pi is great for learning to program or enhancing a physical build, but you can also use it for artistic projects! Whether you're doing digital painting, video editing, or creating light displays, there's a lot you can do with the microcomputer. [77](#)



## ▲ GNU Image Manipulation Program

### Open-source photoshopping

A popular, free alternative to Photoshop, this image manipulator can be installed on Raspberry Pi via the software manager. It's a very powerful piece of software that is continually getting updated.

[gimp.org](http://gimp.org)



## ▲ LightShow Pi

### Musical LEDs

Less an app and more a Python library, this allows you to sync LEDs to music. It's great for holiday-themed light displays or to bring disco back.

[magpi.cc/lightshowpi](http://magpi.cc/lightshowpi)

## ▼ Audacity

### Audio editing

This powerful editor can be used for any kind of audio production – from podcast editing to song mixing. It supports a wide variety of audio files as well.

[audacityteam.org](http://audacityteam.org)



## ▲ Inkscape

### Vector graphics

Vector images are not like traditional digitally drawn art, instead using data points to draw so that images can be scaled up and down without a loss in quality.

[inkscape.org](http://inkscape.org)





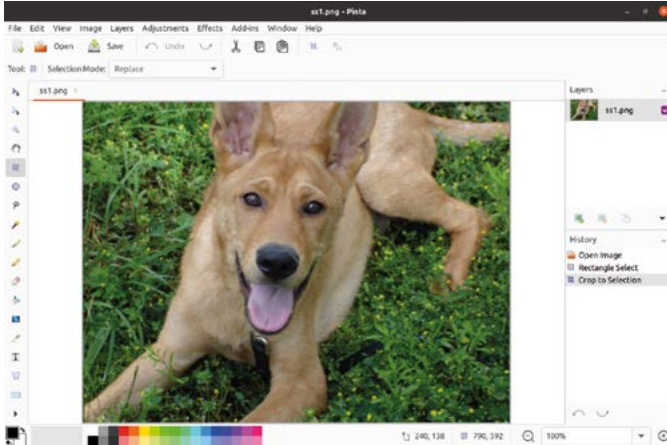

## ▲ Pinta

### Simple editor

A simpler photo editor and drawing app, this is like a cross-platform, yet more powerful, MS Paint.

[magpi.cc/pinta](http://magpi.cc/pinta)

## ▶ Sonic Pi

### Code music

Coding can be creative and artistic, and nothing shows that better than Sonic Pi, which allows you to program audio directly on Raspberry Pi.



[sonic-pi.net](http://sonic-pi.net)



## ▲ OpenShot

### Video editing

Video editors are weird, even by art software standards, and finding one you like is hard. OpenShot, at least, is free and works great on Raspberry Pi, unlike other software.

[openshot.org](http://openshot.org)



## ▲ Krita

### Digital painting

An amazing free digital painting and 2D animation app, Krita easily competes with the likes of Clip Studio Paint and Procreate for drawing – it also has a better tablet GUI as well.

[krita.org](http://krita.org)

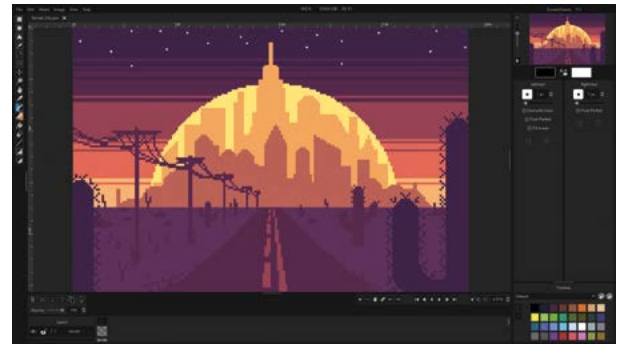

## ▲ Pixelorama

### Lo-fi art

Pixel art never went away and, because of this, there are a lot of pixel-orientated art programs that you can use to make the process easier. Pixelorama is a great one that works on Raspberry Pi.

[magpi.cc/pixelorama](http://magpi.cc/pixelorama)

## ▼ Kdenlive

### Video on Ubuntu

You'll need to have a spare SD card with Ubuntu installed for this. However, Kdenlive is a fairly powerful and free video editor, with decent chroma key effects and more.



[kdenlive.org](http://kdenlive.org)

# Learn LibreOffice

Raspberry Pi is more than up to the task of running free, but powerful, office applications. Start with these invaluable guides, suggests **Rosie Hattersley**

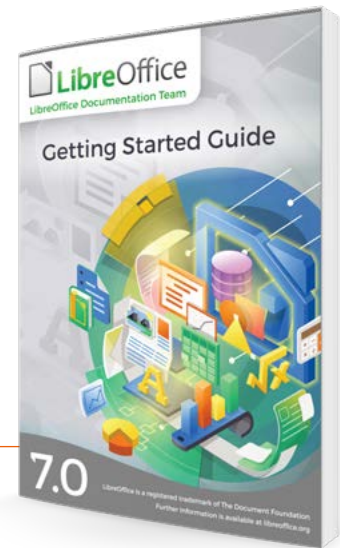

## Getting Started Guide

### AUTHOR The Document Foundation

Price:  
Free download  
[magpi.cc/libreofficestart](http://magpi.cc/libreofficestart)

**LibreOffice is a free, fully-featured office suite that runs like a dream on Raspberry Pi OS.** In fact, you'll find its component programs by clicking the Raspberry Pi icon at the top left of the Raspberry Pi OS desktop, and then hovering your mouse over the Office menu item to reveal Base, Calc, Writer, Impress, Draw, and Math (database, spreadsheet, word processor, presentation, illustration, formula apps,

respectively). Documents produced using LibreOffice are compatible with the likes of Microsoft Office and Google's office apps, so you can write, edit and format text documents, presentations, and spreadsheets in LibreOffice and be confident they will open in other office suites. The Document Foundation (the organisation behind LibreOffice) publishes its own Getting Started guide with each new version of

the software suite, so it's an obvious place to start mastering tasks such as creating documents and applying rules and styles. Running to more than 430 pages, the PDF guide is separated into clearly labelled chapters, so once you've nailed how to work with formulae and sums in the LibreOffice spreadsheet program, you'll be able to jump straight to pivot tables and working with databases.

## Helpful online resources

Quickly get up to speed with these LibreOffice aids

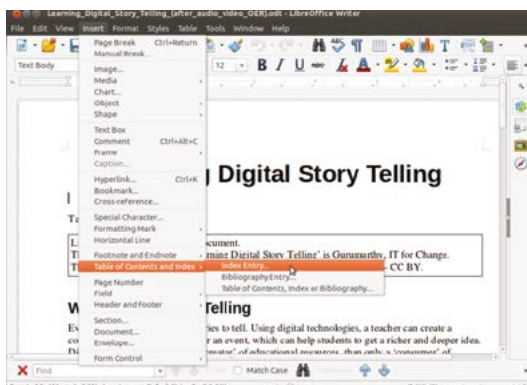

**LEARN LIBREOFFICE WRITER**  
The Teacher Network has a detailed overview of how to use LibreOffice Writer with helpful annotations, a breakdown of the context-sensitive menus, and suggestions about how to format text documents for a professional look that belies the suite's free availability.  
▶ [magpi.cc/teachnetlibre](http://magpi.cc/teachnetlibre)

**LIBREOFFICE ONLINE HELP**  
Get instant assistance without trawling through a lengthy manual by typing a keyword or two into the searchable LibreOffice online help page. It's ideal for finding out

how to achieve a particular effect or calculate something that's not immediately obvious.  
▶ [magpi.cc/librehelp](http://magpi.cc/librehelp)

**LIBREOFFICE SHORT-CUTS**  
If you're an MS Office aficionado, you may well be accustomed to using time-saving short-cut keys to copy and paste portions of text, apply or discard formatting, formulae, styles, and so on. This page displays LibreOffice's default short-cut controls and also explains how to set your own, perhaps matching those you already use elsewhere.  
▶ [magpi.cc/libreshortcuts](http://magpi.cc/libreshortcuts)

# Coursera LibreOffice

**AUTHOR**

## Coursera

**Price:**  
From £8/\$10 per course (annual fee £324/\$399)

[coursera.org](https://coursera.org)

Unlike many of the online guides to LibreOffice, Coursera's go beyond the basic program setup and help you with specific business tasks, such as creating a marketing plan or process flowchart. Generating SQL and database queries within LibreOffice are among the potentially more useful skills you might find helpful. Coursera's approach to online learning is to provide follow-

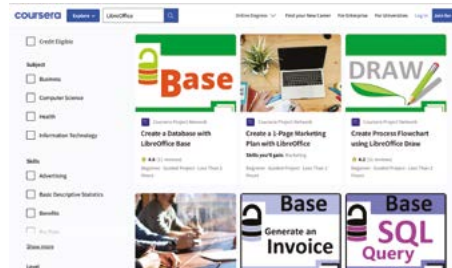

along modules in which you emulate what the trainer does by means of a split screen. This means you can be sure that you have completed the steps required for each task. The subscription model for Coursera will serve you well if you're keen to gain confidence across multiple disciplines.

# LibreOffice websites

Step up your LibreOffice game



## IMPRESS TEMPLATES

The presentation tool Impress has had an update to version 7.4 and it now supports themes, making for smarter slides. For a more bespoke look, head to this GitHub page where you'll find all manner of instantly downloadable templates.

► [magpi.cc/impresstemplates](https://magpi.cc/impresstemplates)

## OS COLLEGE

OS College specialises in helping people get the most from open-source software. It has a whole section with advice on setting up and using LibreOffice programs and YouTube tutorials. It also includes details of web-based use and setting up LibreOffice with a server for online access.

► [oscollege.com](https://oscollege.com)

## NEURONICA

The Extensions library for LibreOffice provides a wealth of extras that tailor the suite to your needs. One such example, Neuronica, exploits neural networks and machine learning to turn Calc into a tool for data crunching and trend analysis.

► [extensions.libreoffice.org](https://extensions.libreoffice.org)

# LibreOffice online tutorials

**AUTHOR**

## Udemy

**Price:**  
From £16/\$15

[magpi.cc/udemylibre](https://magpi.cc/udemylibre)

Udemy has a solid reputation for providing online training sessions for all manner of software, and the second-most-used office suite is no exception. While most people will need to

stump up around £16 for each course, there are small group and educational discounts and, if you're looking to avoid the monthly cost of Office 365 for your team, a modest training outlay could make sense. Choose from introductory sessions on Writer, Calc, and Maths or more focused training modules for forecasting using the spreadsheet app. There's an option to preview a session before signing up, and you can pause, speed up, rewind, and skip through each video. Note that classes are primarily Windows-based, but the tips learned can be applied on any Libre-supported platform (Linux, macOS, or Windows). 



# Build your own simulated PC

PC BUILDING SIMULATOR 2 / **£19.99** inc VAT

DEVELOPER Spiral House Ltd / PUBLISHER Epic Games Publishing

**C**osting just £20, PC Building Simulator 2 gives you an affordable, fun way to play with all the hardware you've seen in these pages or further afield. It's also a useful way to learn how to build a PC and learn what goes where, as well as to see how your PC will look.

The new game improves over the original in a number of ways too. For starters, there's definitely an added sense of visual prowess and realism to the components. The features don't just include more PC components either, as you can enter the EFIs of completed PCs, overclock them, stress-test them, and

**Use a thermal imaging camera to see whether your PC is overheating**

even alter memory timings. Want to practise entering the EFI for some overclocking using the Del key? Well, you can do just that here without fear of messing up anything.

## A new career

The build process is accurate down to small details, such as removing side panel screws and expansion slot covers. If you head to Career mode, the game will actually take you through these motions and the process of building a whole PC, along with a role-playing game where you run a PC shop.

You receive emails from customers asking for their PCs to be rid of viruses, upgraded, or even spray-painted, all the while you're

aiming to keep an ailing PC repair shop afloat and earn money, learning useful PC building and troubleshooting tips in the process. It's an interesting dynamic that helps to lessen the learning curve of not only building a PC, but also how to use the simulator.

Some parts are deliberately repetitive, such as removing individual screws or case components, or connecting individual cables. There's method to this, though, as it means you see where those cables go, and even use the game as a guide, as you can clearly make out different port and cable types.

## Thousands of component choices

Switching to the Free Build mode gives you the ability to pick from thousands of component combinations, and the scale of the database of rendered items is staggering. There are graphics cards of all shapes and sizes, CPUs, motherboards, and cases of all popular form factors, along with storage

**You can bend the rigid tubing an infinite number of times until you get it just right**



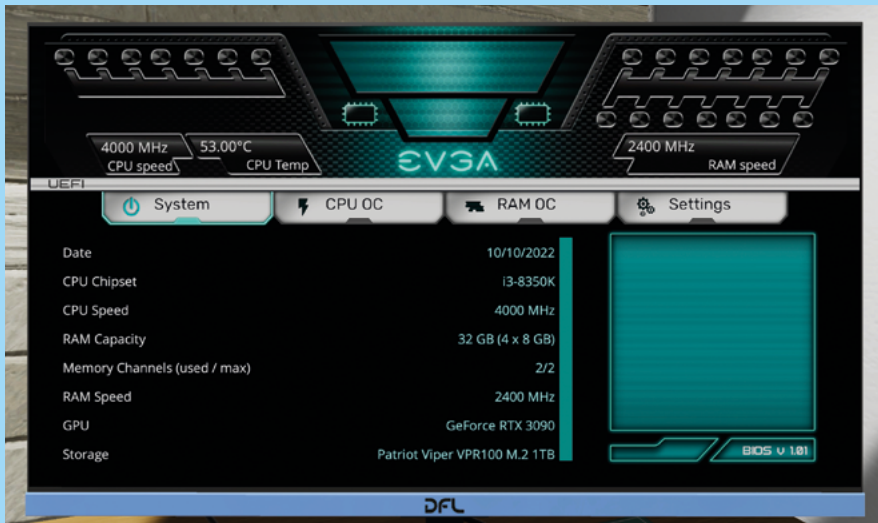

**You can enter the EFI to try overclocking your system without fear of messing up anything**

devices, PSUs and even waterblocks, custom cables, and fans.

There's everything you need to pick your dream bunch of hardware and then see how it looks when it's all assembled. What's more, as the products are based on actual parts, you're able to see how your chosen graphics card will look in a certain case, whether it fits, and even choose between vertical and horizontal mounts with compatible cases.

### Plan your loop

You can delve into even greater depths too, such as creating your own water-cooled PC with rigid tubing. You can bend the tubing an infinite number of times until you get it just right, with the benefit of seeing what looks best when your virtual PC is powered on. As rigid tubing is expensive, this is a very useful feature for planning a water-cooled build.

**With this latest edition, there's an added sense of visual prowess and realism to the components**



You get custom benches from which to work as well. If you want to mod your PC with vinyl stickers and spray paints, you'll want the modding table, with water cooling and standard work bench options too. If only we all had this much space at home.

### Use your virtual rig

One feature we found extremely useful was the ability to test and use the PC you've built. You can enter its virtual OS, install programs such as Cinebench and 3DMark. You can even run fan-control software including fan curves with which you can tinker, then use a thermal imaging camera to see how it performs.

The idea is that if you build a PC and don't add enough fans, or install them incorrectly, the camera will show your PC getting hot. The data is simulated rather than obtained from a nightmarish task of testing thousands of component combinations. However, the



**Play at running a computer shop to get used to the PC building process**

data from benchmarks is based on real-world data for those components. The PC will even blue screen too, which doesn't sound like a fun gaming feature, but again, it's designed to emphasise components overheating and teach you about the quirks that seasoned PC enthusiasts know how to avoid.

Adding a couple more case fans or using a bigger CPU cooler, for example, can show real-time improvements, so it's not just checking compatibility between components, it's making sure the physics are working too.

Whether you're a seasoned pro, or if you've never touched a piece of PC hardware, there's something for everyone here – planning your water-cooling loop, working out how to get into your motherboard's EFI and taking those first steps in setting up your own PC.

The free 1.1 Update for PC Building Simulator 2 has launched, bringing support for the GeForce RTX 4090, AMD Ryzen 7000-series CPUs, Intel ARC and Raptor Lake, plus much, much more. The game is more detailed, dynamic, and useful than the original, and it's available from the Epic Games Store ([store.epicgames.com](https://store.epicgames.com)) for £19.99 inc VAT.

**Head to the modding table if you want to mod your PC with vinyl stickers and spray paints**

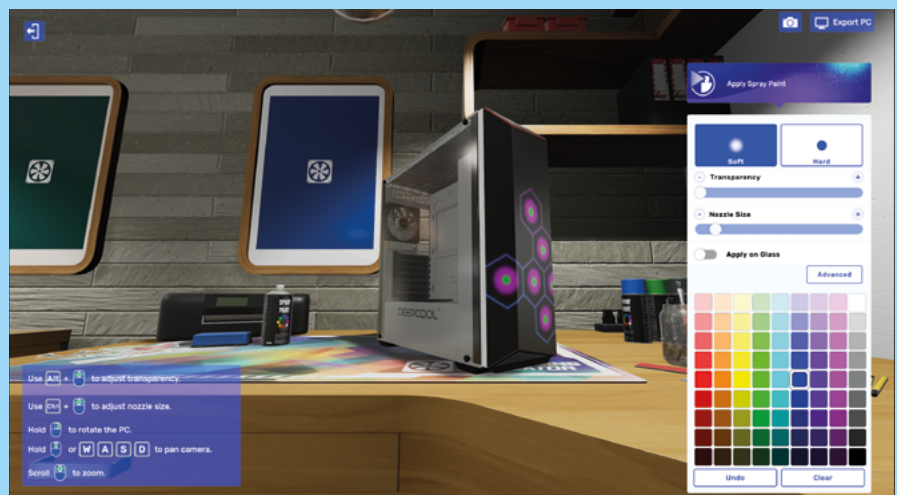



# Alex Martinez

Bringing computing education and making to Puerto Rico

- Name **Alex Martinez** | ➤ Occupation **Teacher**
- Community role **Mentor** | ➤ Twitter **@DeMarquesina**

**P**i Wars may famously be an offshoot of CamJam, the Cambridge Raspberry Jam, but it's not just limited to makers from that pocket of England. There are people who come from near and far to participate and, during the 2021 Pi Wars At Home competition, it even reached the Caribbean island of Puerto

Rico, and makerspace organiser Alex Martinez.

"I am a former geologist that ended up teaching computers in our hometown Uno Academy School," Alex tells us. "I teach the use of computers to kids from 1st-12th grade in the school. In 2017, I founded with my kids 'Talleres de Marquesina' Makerspace, a

community makerspace in our home garage where we make many projects and share workshops with kids and family. I love new tools and learning new skills; right now I am learning to sew garments for my daughter. Also, I am mentoring deaf kids at Colegio San Gabriel in the SeaPerch underwater robotic program."

▼ This beastie-like robot is ready to take on any challenge

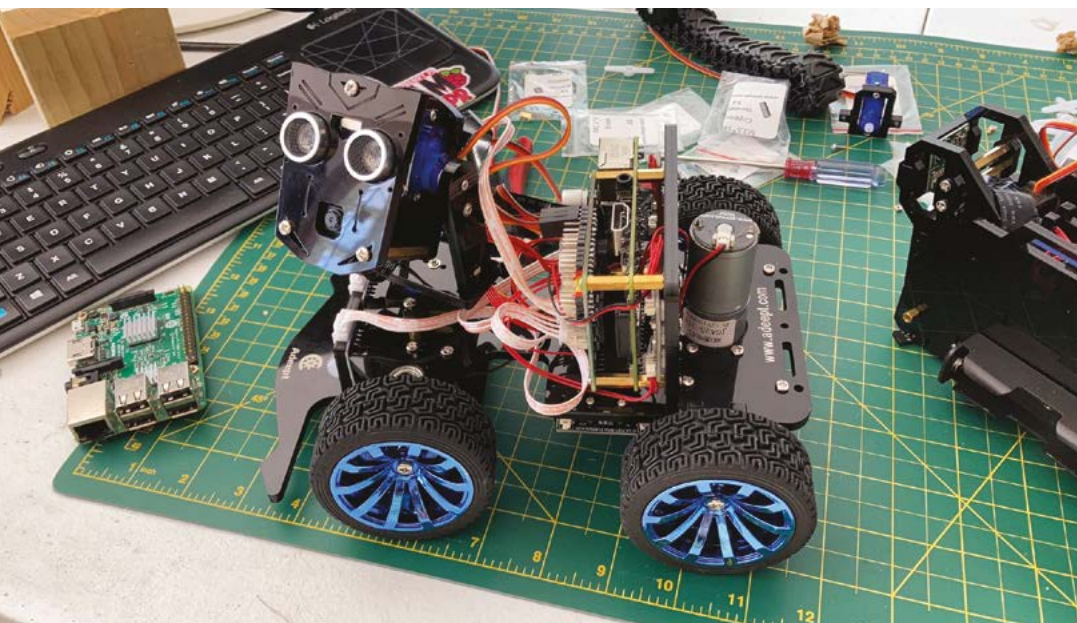

## What is your history with making?

From a very young age, I was very interested in building model airplanes and rockets. In school, I loved the woodshop program where we learned about tools and crafts. I think it is where the love for making started. But it was the Arduino ecosystem that sparked many projects in my adulthood; [I] mainly loved making wearables. Then we learned about digital fabrication with a 3D printer kit we built at home. Later we dived into the Raspberry Pi world, which helped me teach about computers and programming to kids in many workshops and classes around the island.



▲ Have you ever tried to code a robot so that it can stay upright on a see-saw?

We can summarise my adventure as a learning and sharing journey with others.

### When did you first learn about Raspberry Pi?

In 2016 a friend from the makerspace showed me that the Raspberry Pi Foundation was coming to the USA to reach out to educators with Picademy. I enlisted and entered the first cohort of Raspberry Pi Certified Educators. It was an awesome experience to become a Raspberry Pi Certified Educator, mainly because of other educators' openness to share

in a summer camp about robots, so I read and learned how to control motors and servos with Arduino. We bought a cheap Arduino kit for that camp and used online tutorials and books to teach me the subject. Then I came across the CamJam robotics kit [EduKit 3] when I entered the Raspberry Pi and Python world. I believe it is the easiest tool to teach robotics to kids.

### What have been some favourite moments from Pi Wars?

One of the best moments was when a local WAPA-TV host invited us to a morning session

“ Visiting a TV station was an amazing experience for all of us ”

teaching techniques to introduce Raspberry Pi in the classroom. Since then, I have been teaching computer programming and making workshop sessions for kids here in Puerto Rico.

### What's your history with robotics?

My journey in robotics started in 2015 when I needed to teach kids

to share our Pi Wars journey with people across the island and some parts of the US. Visiting a TV station was an amazing experience for all of us.

The other was making videos for the competition. Our kids are very enthusiastic and very spontaneous; they made us laugh all the time. But on the last day to enter the videos,

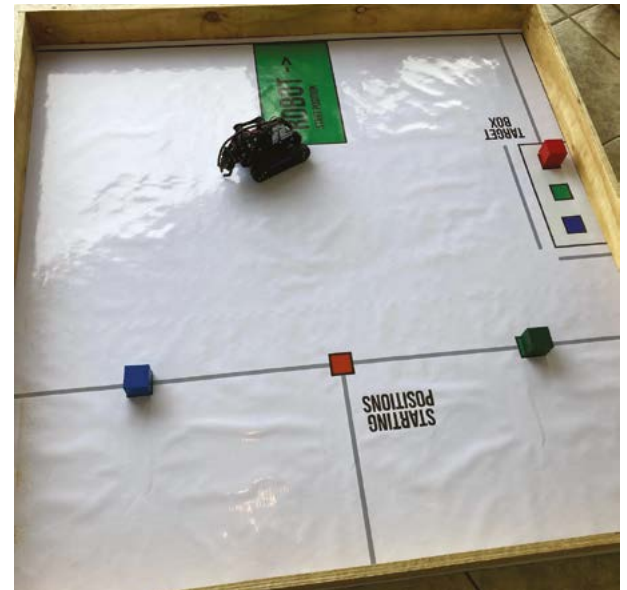

▲ A true test of skill for this robot is the precision to sort these coloured blocks

one of the motors of the robot failed on the spot and they felt so bad. That is where we had the opportunity to teach them about resilience and problem-solving skills. Two hours later we fixed the robot with slower motors, but they learned to never give up and to overcome. We came second place that year with a great life lesson for them. 🏆

▼ The Pi Wars Puerto Rico team proudly representing themselves



# MagPi Monday

Amazing projects direct from our Twitter!

**E**very Monday we ask the question: have you made something with a Raspberry Pi over the weekend? Every Monday, our followers send us amazing photos and videos of the things they have made.

Here's a selection of some of the awesome things we got sent this month – and remember to follow along at the hashtag #MagPiMonday! 📷

01. This is some kind of wood-based tongue-twister that we refuse to say out loud
02. We love to see a good upcycling project, and this mini camera does not disappoint
03. Fantastic photos of a very cool device for checking out your home's heating
04. Excellent use of the new Raspberry Pi Camera Module 3 by Kevin
05. We look forward to the big LED cube's final form
06. Our weather camera would just confirm that is indeed raining again
07. Now this is a very cool custom build – well worth the five month wait!
08. Pico robots are always very cool to us
09. Extra support was added in case anyone really wanted to whack the button
10. This is an amazing project with excellent educational applications!

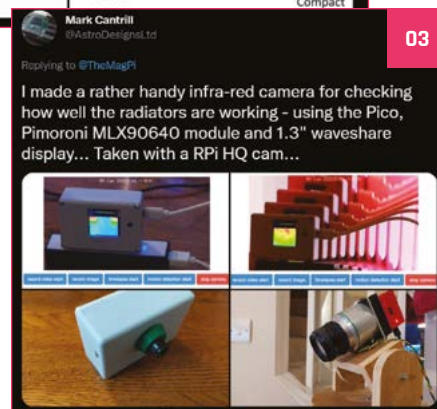



**04**

Kevin McAleer  @kevsmac

Replying to @TheMagPi

Happy #MagPiMonday

This weekend I've been playing with the new Raspberry Pi Camera Module 3, and fitting it to Cubie-1; the robot I've designed to help me learn ROS.

The Wide angle camera works really well on the front of the robot & autofocus keeps the image sharp!

#ShotOnPi



**05**

Dr Footleg - Roboteer @drfootleg@fosstodon.org

Replying to @TheMagPi

I'll have to forego the bonus points for using the camera as you only released it today, so only those with advanced review samples can get one in time for this weeks #MagPiMonday

But I did a lot more wiring of the internal electronics for my #LEDcube ready to connect a Pi4 now.



**06**

SPACEMOUSE @SpaceMousey

Replying to @TheMagPi and @Raspberry\_Pi

Pi 2B weather camera I just finished!

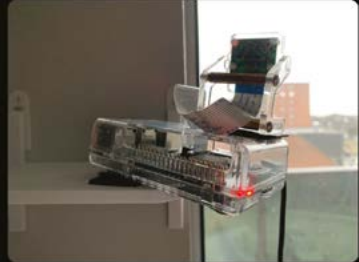

**07**

Aiffo Tennant @Aiffo\_Tennant

Replying to @TheMagPi

I started this Pi4 project back in July but at long last my little joystick arrived from China today to finish it off



**08**

RPiKitchenChef @RpiKitchen

Replying to @TheMagPi

It's a #Pico driving some continuous rotation servos from one of my own PCBs and a 3d printed case. Now I need to add some sensors.

[rpikitchen.wordpress.com/2022/10/23/dev...](http://rpikitchen.wordpress.com/2022/10/23/dev...)

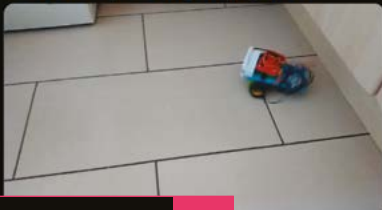

**09**

Stewart Watkins @stewartwatkins

Replying to @TheMagPi

Just before Christmas I finished my Raspberry Pi Pico based reaction game. Featuring NeoPixels and giant hit to play button!

[penguintutor.com/projects/led-r...](http://penguintutor.com/projects/led-r...)



**10**

Lewis Workshop @LewisWorkshop

Replying to @TheMagPi

Finally finished off this project for the small human. RFID spelling game with a Pimoroni Pico Lipo.



0:08 | 1,740 views

**11**

Andy Hudson-Smith  
@digitalurban

Update of the traditional Weather House - A Data House using Open Weather Map, Pi picow and a 360 servo - with a mix of Laser cutting and 3D printing  
#MagPiMonday @Raspberry\_Pi



**12**

TGD  
@TGD\_Consulting

Replying to @TheMagPi

Winter season greetings from Mr.Snow. The GC9A01 display of RCjoy is working well.  
#RaspberryPi #PicoW #RP2040 #STEM #coding #IoT #robotics #robots



**15**

Scott Young  
@thecobotdick

Replying to @TheMagPi

Just watching live images from the ISS via a pi 3A thanks to some @ISSAboveYou magic - brought back to life cause we keep looking at the sky and going 'is that the ISS?', now we'll know! Plan is that this goes in a frame with a small screen and gives 24/7 space joy!  
#MagPiMonday

**13**

Pater Practicus  
@PaterPracticus

Replying to @TheMagPi

@Raspberry\_Pi Pico powered Xmas tree water monitor is up and running.



**14**

Simon Prickett | simonprickett.dev  
@simon\_prickett

Replying to @TheMagPi

Tracking the ISS as part of a multi function portal I'm building as a gift on a Pi Pico W / Pimoroni Pico GFX #MagPiMonday #raspberrypi video sped up, backlight gets greener the closer ISS is to me.

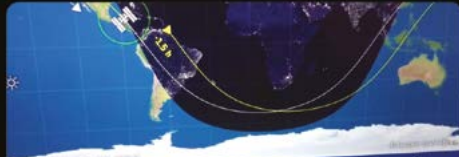



**16**

Stephen Smith  
@smist08

Replying to @TheMagPi

Playing with an IR camera, 3D printed a case, even have a tripod. First experiments with pycamera.



11. To paraphrase a world-famous model: is this a house for ants?
12. Mr Snow looks like a very nice chap
13. We'd hook one up to our tree but it is, unfortunately, very plastic
14. Two ISS-based projects in one month? Everyone must have Space Fever (the good kind)
15. After all these years, it's still amazing to see Raspberry Pi ISS projects
16. This could easily be upgraded with a Camera Module 3, we think

# Crowdfund **this!** Raspberry Pi projects you can crowdfund this month



## PiKVM V4

"In the heart of the new PiKVM V4 is a Raspberry Pi Compute Module 4 CM4102000 with 2GB of RAM, Wi-Fi, and Bluetooth. PiKVM is not just an add-on for a Raspberry Pi board, but a stand-alone compact device designed with all our experience."

► [kck.st/3PzBR1Q](https://kck.st/3PzBR1Q)



## Raspberry Pi Breakout, Breadboard & Prototype SM/TH Kit

"If you consider yourself handy with the soldering iron, and are familiar with the Raspberry Pi, you can use this kit to breadboard and test ideas. You can even make final products which you can use to automate your home - control lighting and much more."

► [kck.st/3vltWpA](https://kck.st/3vltWpA)

# Together we can make a difference

## Give young people the opportunity to learn about technology

The Raspberry Pi Foundation enables young people to realise their full potential through the power of digital technologies, but we can't do this work without your help. Your support helps us give young people the opportunities they need in today's world. Together we can offer thousands more young people across the globe the chance to learn to create with digital technologies.

**Generous donations from organisations and individuals who share our mission make our work possible.**



**DONATE NOW**

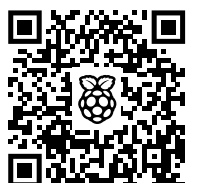

Donate today to make a difference: [rpf.io/magpidonate](https://rpf.io/magpidonate)

# Your Letters

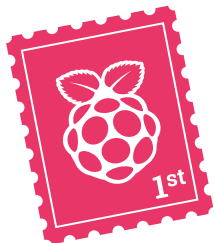

## Supercomputers

I remember reading an article about a team who built a Raspberry Pi 'supercomputer'. Can you remind me which issue that was in please? It was by a British university and was the first time it had been done.

Bradley via email

This is a tricky one, as there have been a lot of Raspberry Pi supercomputers that we've covered over the years, and none we can think of that was specifically British.

Hopefully, we can help with some links – the SeeMore sculpture is the first one that comes to mind when talking about supercomputers or cluster computers: [magpi.cc/seemore](http://magpi.cc/seemore). OctaPi is an older project that uses eight Raspberry Pi for this: [magpi.cc/octapi](http://magpi.cc/octapi).

There's also a more recent tutorial as well, that you can find here: [magpi.cc/newcluster](http://magpi.cc/newcluster).



▲ We're not sure where SeeMore is now, but hopefully it's still crunching numbers somewhere

▼ The official documentation is an incredible source for just about anything you'd like to know about Raspberry Pi hardware

**Serial Peripheral Interface (SPI)**

Raspberry Pi computers are equipped with a number of SPI buses. SPI can be used to connect a wide variety of peripheral devices, including sensors, cameras, Ethernet, CAN bus, and so on. These devices are not supported by normal serial drivers, and the SPI interface allows users to write their own kernel drivers or use the SPI interface to write their own kernel drivers.

**SPI Hardware**

Raspberry Pi Zero, 1, 1.5, and 2 have three SPI controllers.

- SPI0, with two hardware chip selects, is available on the header of all Raspberry Pi boards. There is also an alternate mapping that is only available on Compute Modules.
- SPI1, with three hardware chip selects, is available on all Raspberry Pi boards except the original Raspberry Pi Model B and Model B+.
- SPI2, with three hardware chip selects, is only available on Compute Modules 1, 2 and 3.

On the Raspberry Pi 400 and Compute Module 4 there are four additional SPI buses (SPI3 to SPI6, each with 2 hardware chip selects). These are not SPI buses and are available via alternate function assignments on certain SPI0 pins – see the [GPIO Pin Function Tables](#) for details.

Chapter 18 in the [Raspberry Pi Hardware](#) document describes the main controller. Chapter 23 describes the auxiliary controller.

**Pin/GPIO mappings**

SPI	GPIO Function	Raspberry Pi 400	Raspberry Pi 400	Raspberry Pi 400	Raspberry Pi 400
SPI0	CS0	18	SP0CS0	SP0CS0	SP0CS0
	CS1	22	SP0CS1	SP0CS1	SP0CS1
	CS2	23	SP0CS2	SP0CS2	SP0CS2
	CS3	24	SP0CS3	SP0CS3	SP0CS3
SPI1	CS0	18	SP1CS0	SP1CS0	SP1CS0
	CS1	22	SP1CS1	SP1CS1	SP1CS1

**SPI alternate mapping (Raspberry Pi 400 only, except CM4)**

SPI	GPIO Function	Raspberry Pi 400	Raspberry Pi 400	Raspberry Pi 400
SPI0	CS0	SP0CS0	SP0CS0	SP0CS0
	CS1	SP0CS1	SP0CS1	SP0CS1
	CS2	SP0CS2	SP0CS2	SP0CS2
	CS3	SP0CS3	SP0CS3	SP0CS3

## Serial GPIO

Is there an issue of *The MagPi* that details how to use the GPIO as a serial port, and maybe specifically with Raspberry Pi 4? If not Raspberry Pi 4, any info would help.

Karl via email

We've not done any specific issues or tutorials about using the GPIO as a serial port. However, it is entirely possible to do so. The official Raspberry Pi documentation is very extensive though, and covers using GPIO as serial. Check them out here: [magpi.cc/docs](http://magpi.cc/docs).

## Contact us!

- ▶ Twitter [@TheMagPi](https://twitter.com/TheMagPi)
- ▶ Facebook [magpi.cc/facebook](https://facebook.com/magpi)
- ▶ Email [magpi@raspberrypi.com](mailto:magpi@raspberrypi.com)
- ▶ Online [raspberrypi.org/forums](https://raspberrypi.org/forums)

## New radio URLs

Might I suggest a subject for discussion by one of your regular writers? We use one of Pimoroni's Pirate Radios for our everyday listening. Just recently, the BBC has started interrupting programmes to tell us that, in mid-2023, the links we use for BBC programmes will stop working. They suggest that those hearing the warning should contact the manufacturers of the equipment they use, or use BBC Sounds. The BBC do not (as far as I know) give access to Sounds to Linux machines except via a browser. I contacted the BBC to request assistance. I explained that the open-source VLC software we use means that we need to have new URLs to use. They have replied, but unhelpfully. I am sure that many other readers of *The MagPi* would appreciate information on a solution to this problem.

David via email

This is a new one to us, but it will definitely affect a lot of Raspberry Pi internet radio listeners. We have not found a solution at the time of writing, but we will look into this and, hopefully, have a fix in a future issue. Hopefully we can work with Pimoroni on it as well...



▲ This Raspberry Pi Zero project is a great little internet radio, which apparently now needs an update

# USA SPECIAL! 6 ISSUES FOR \$42



## FREE RASPBERRY PI PICO W



Subscribe online:  
[magpi.cc/subscribe](https://magpi.cc/subscribe)

Price is charged at £35 sterling. The dollar price will depend on the exchange rate. Six issues and free Pico W for £35 is also available in Canada and Europe. Subscription is for the next six issues and does not renew automatically. This is a limited offer. Offer subject to change or withdrawal at any time.

# Your FREE guide to making a smart TV

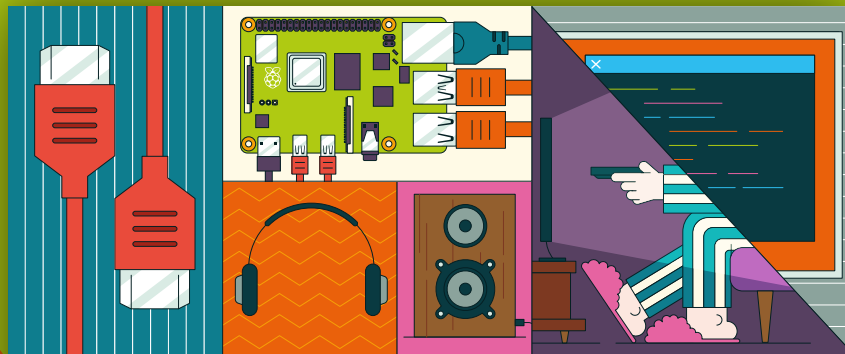

## BUILD A RASPBERRY PI MEDIA PLAYER

Power up your TV and music system

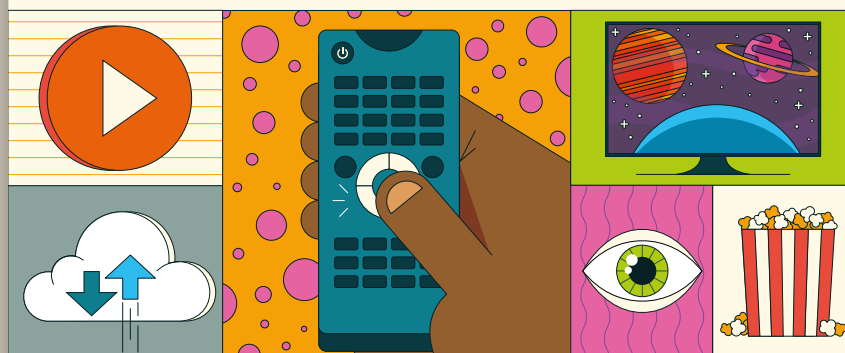

FROM THE MAKERS OF *MagPi* THE OFFICIAL RASPBERRY PI MAGAZINE

[magpi.cc/mediaplayer](http://magpi.cc/mediaplayer)

# WIN ONE OF TEN

## RASPBERRY PI CAMERA MODULE 3

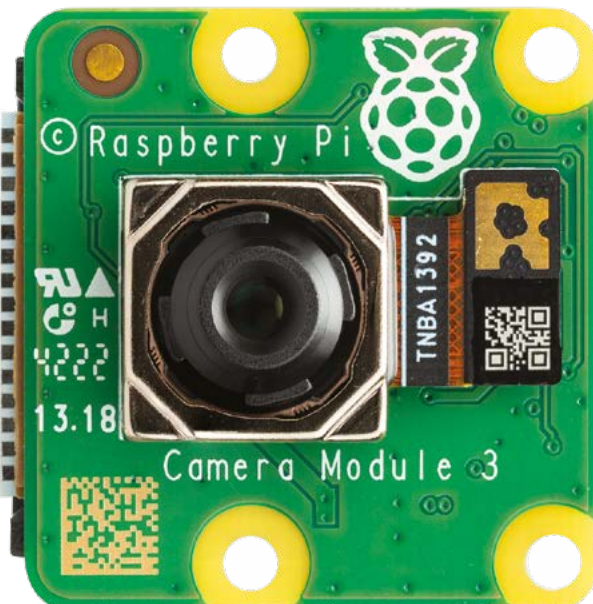

Take amazing pictures with the brand new Raspberry Pi Camera Module 3, which we cover extensively on page 36. We have ten of the standard version to give away.

Head here to enter: [magpi.cc/win](https://magpi.cc/win) | Learn more: [magpi.cc/camera3](https://magpi.cc/camera3)

### Terms & Conditions

Competition opens on 25 January 2023 and closes on 23 February 2023. Prize is offered to participants worldwide aged 13 or over, except employees of Raspberry Pi Ltd, the prize supplier, their families, or friends. Winners will be notified by email no more than 30 days after the competition closes. By entering the competition, the winner consents to any publicity generated from the competition, in print and online. Participants agree to receive occasional newsletters from The MagPi magazine. We don't like spam: participants' details will remain strictly confidential and won't be shared with third parties. Prizes are non-negotiable and no cash alternative will be offered. Winners will be contacted by email to arrange delivery. Any winners who have not responded 60 days after the initial email is sent will have their prize revoked. This promotion is in no way sponsored, endorsed or administered by, or associated with, Instagram, Facebook, Twitter or any other companies used to promote the service.

sinclair



Commodo

the

COMPUTERS

THAT MADE

BRITAIN



OUT NOW

*"The Computers That Made Britain is one of the best things I've read this year. It's an incredible story of eccentrics and oddballs, geniuses and madmen, and one that will have you pining for a future that could have been. It's utterly astonishing!"*

- **Stuart Turton**, bestselling author and journalist

.....



Buy online: [wfmag.cc/ctmb](http://wfmag.cc/ctmb)





# RASPBERRY PI TIPS & TRICKS

Learn  
Raspberry Pi  
& Pico insider  
**SECRETS**



**PLUS!**  
#MonthOfMaking  
**RETURNS**

**THE MAGPI #127**  
**ON SALE 23 FEB**

## Plus!

A robot arm that plays Snake

**Build your own message in a bottle**

Recreate BBC Micro with Raspberry Pi 400

DON'T MISS OUT!

**magpi.cc/subscribe**

**TWITTER** @TheMagPi

**FACEBOOK** fb.com/MagPiMagazine

**EMAIL** magpi@raspberrypi.com

## EDITORIAL

### Editor

Lucy Hattersley  
lucy@raspberrypi.com

### Features Editor

Rob Zwetsloot  
rob@raspberrypi.com

### Sub Editor

Nicola King

## ADVERTISING

Charlotte Milligan  
charlotte.milligan@raspberrypi.com  
+44 (0)7725 368887

## DESIGN

criticalmedia.co.uk

### Head of Design

Lee Allen

### Designers

Olivia Mitchell, Ty Logan,  
Sam Ribbits

### Illustrator

Sam Alder

## CONTRIBUTORS

James Adams, David Crookes,  
Ben Everard, Rosemary  
Hattersley, Nicola King, Phil King,  
Nik Rawlinson, Toby Roberts,  
Eben Upton

## PUBLISHING

### Publishing Director

Russell Barnes  
russell@raspberrypi.com

### Director of Communications

Liz Upton

### CEO

Eben Upton

## DISTRIBUTION

Seymour Distribution Ltd  
2 East Poultry Ave,  
London EC1A 9PT  
+44 (0)207 429 4000

## SUBSCRIPTIONS

Unit 6 The Enterprise Centre  
Kelvin Lane, Manor Royal,  
Crawley, West Sussex, RH10 9PE  
+44 (0)1293 312193  
magpi.cc/subscribe  
magpi@subscriptionhelpline.co.uk



This magazine is printed on paper sourced from sustainable forests and the printer operates an environmental management system which has been assessed as conforming to ISO 14001.

The MagPi magazine is published by Raspberry Pi Ltd, Maurice Wilkes Building, St. John's Innovation Park, Cowley Road, Cambridge, CB4 0DS. The publisher, editor, and contributors accept no responsibility in respect of any omissions or errors relating to goods, products, or services referred to or advertised in the magazine. Except where otherwise noted, content in this magazine is licensed under

a Creative Commons Attribution-NonCommercial-ShareAlike 3.0 Unported (CC BY-NC-SA 3.0). ISSN: 2051-9982.





# Smart Camera

One of the more interesting uses of AI lies in the lens, thinks **Rob Zwetsloot**

**I**f, like me, you are cursed to browse Twitter and other social media a good portion of your day, you may have noticed the hubbub around AI art. New companies have used advanced AI algorithms and thousands upon thousands of images and art pieces posted online to create art generators that output very convincing pictures.

The tech itself is extremely impressive. However, there are many moral and ethical questions around the art it's learning from – especially if the art itself was used without the consent of the artist. Also, the hands and eyes always look weird.

Similar things can be said about text generators like ChatGPT. We've seen people use it to create a jumping on point for simple Python code, which is an interesting use of open-source scripts. However, for actual text... well, the best way I've seen it described is 'confidently wrong'. For very basic stuff, you might get something competent, but anything else and it's better to get a person involved.

## Computer vision

Over the years, we've made great use of OpenCV in many Raspberry Pi projects – it's a machine learning tool that processes image data to help make decisions. It's used in robotics a lot with a Raspberry Pi

“ I'm especially happy when I get to make something cool and talk about what ”

Camera Module, with the late, great Formula Pi robots doing stellar work with it as they zipped around.

This use of AI is great. It's doing something people can sort of do, but if you were doing these tasks it would be a bit menial. And the AI can do it a lot faster.

I've also seen people use image recognition technology with Raspberry Pi to create a Pokédex from the Pokémon anime – a device that recognises the eponymous

monsters – and simply a 'magic wand' that identifies what it's being pointed at. Both work to varying degrees of success. However, humans only know a limited amount of knowledge too.

## Ethical future

We're currently at a tipping point with a lot of AI tech. It's getting very interesting and very powerful, but the technology should not be replacing human expression – especially when it's copying other humans' expressions without any context. The way it's been used in computer vision is a good template for the future – as an aid and not a pseudo-replacement. Art is important expression after all.

With the new Camera Module 3 and its laundry list of new features, I can only imagine what we'll be able to do with it that a person cannot. ”

## AUTHOR Rob Zwetsloot

Rob has checked and he's not an AI because he's unable to learn anything.

[magpi.cc](http://magpi.cc)

HiPi.io

# HIGHPI PRO

•———— The new case from the HiPi.io team ————•



- Rapid tool-free assembly and disassembly
- Large internal volume for HATs
- Compatible with Pi 2/3/4
- Multiple lid options
- Passive & Active Cooling options
- Secure microSD card cover
- VESA mount support
- Molding-configurable output ports customizable for volume orders
- Printed logo for your branding

Available at these great Pi stores:



Contact your favorite Pi store if it's not listed here

# PiKVM

Manage your servers or workstations remotely

A **cost-effective** solution for data-centers, IT departments or remote machines!



**PiKVM HAT**  
for DIY and custom projects



**Pre-Assembled version**

- Real-time clock with rechargeable super capacitor
- OLED Display
- Bootable virtual CD-ROM & flash drive
- Serial console
- Open-source API & integration
- Open-source software

Available at the main Raspberry Pi resellers



Reseller suggestions and inquiries:  
**wholesale@hipi.io**